



High Quality Commercial Tapware & Products

3+ Ranges certified Australian Made



For R.O. Water See our Stainless Steel Tapware Inside



Phone: 1300 852 515 or 07 3855 2350

Fax: 07 3112 1916

Email: sales.info@globaltapware.com

www.globaltapware.com.au

INDEX

PAGE	PRODUCTS
1	Cover
2	Index
3	WARRANTY and GENERAL INFORMATION
4 - 5	Fisher Pre Rinse - Deck & Wall -Standard & Pot Filler Models - (mix of S/S & Chrome components) - Deck & Wall -Standard & Pot Filler Models - (Full Stainless Range for R.O. applications)
6	Fisher Pre Rinse - Deck & Wall - Hanging & Line Retractor Models
7	Fisher Pre Rinse - Deck & Wall - Supermarket Designs (w/- Add-on Side Tap)
8 - 9	Stainless Faucets - Deck & Wall - Standard Spouts / Cleaners Sink
10 - 11	Stainless Faucets - Deck & Wall - Gooseneck & Kettle / Wok Spouts / Fillers w/- End Taps
12 - 13	Rinse Maid Pre Rinses - Deck & Wall - Standard Models & Pot Filler Models
14 - 15	Easy Clean (EC) Faucets - Deck & Wall - Standard Spouts
16 - 17	Easy Clean (EC) Faucets - Deck & Wall - Gooseneck & Kettle / Wok Spouts/ Fillers w/- End Taps
18 - 19	Q' Model - Single Pin Handle - Deck & Wall - Standard Spout
20 - 21	Q' "Junior SCHOOL" Model - (Tri Pin Handle) - Deck & Wall - Standard Spout
22 - 23	Q' 'LEVER' Models -Deck & Wall - Standard Spouts
24 - 25	HandZfree Tapware & Basins - Deck & Wall - Electronic Sensor & Manual Push / Knee Taps or Basins
26 - 27	General Plumbing - Mixers - Scrap Catcher (Basket & Pop Up) - Bib Tap
28 - 29	Wash Ware - (Hot Wash) Hose Reels & Hoses / Washdown Guns / Combi Guns & Kits
30 - 31	Accessories & Spare Parts - HOSES - PR SPRAY GUNS - REPAIR KITS - Spring Guards
32 - 33	Accessories & Spare Parts -POT FILLERS - RISERS - BRACKETS - FITTINGS - Line Retractor - Quick Release
34 - 35	Accessories & Spare Parts - 1/2" SPOUTS - 3/4 REPAIR KITS & PARTS - OTHER BRANDS PARTS
36	Tap Bodies Only - S/S & Chrome
37 - 38	Product Drawings
39	Technical Information
40	BACK COVER

Hi,

January 2017

Welcome to our latest Catalogue & pricelist. We hope that you will get a lot of use & knowledge out this new layout. We have tried to make it more user friendly than in previous versions.

If you are a new or an existing customer I would like to take the time to welcome you to Global Tapware. We have been trading now since 1991 and we always put the customer / end user first in all our endeavours. It is important to us that issues do not arise and if they do, we deal with them straight away, with that in mind as the owner of the business I take great pride in saying that from annual 'Watermark' Audits it is shown time and again that across all product groups we only have .5 to 1% of warranty issues. We aim to keep it that way, as I know nothing is 100%. So take it as a given you are buying the best of the best.

Regards

Mark McQueen

General Information

This publication is for general use only, any pricing and information may change at any time. It would always be best to check prices with the office before placing orders. Due to the nature of importing components from the USA we are governed by the exchange rate & freight charges, as such we reserve the right to alter prices with out notice. We do our best to only having one price change per year.

All prices are RRP (excluding GST) based. Exceptions are where products are coded 'GZ', which are a net price, or a 'GFZ or GZX', in which case these indicate a restriction of discounting. These codes over-rides any special price agreement we may have with your company.

We reserve the right to make changes to this 'Catalogue / Pricelist' without notice.

Warranty

	Product	Period from Installation Date.
1	Fisher Pre Rinses	36 months
2	Fisher Universal KITS	36 months
3	Stainless Faucets	36 months
4	RinseMaid Pre Rinses	18 months
5	EC Faucets	18 months
6	Q Faucets -ALL Ranges	18 months
7	Mixers	12 months
8	HandZfree Faucets	12 months
9	HandZfree Basins	12 months
10	Scrap Catchers - Basket	12 months
11	Scrap Catchers -Twist	12 months
12	Hose Reels & HW Hoses	12 months
13	Wash Down Guns	12 months
14	Combi Kits	12 months
15	Spare Parts	12 months
16	Special Design Hoses	12 months

All Consumer rights are implied and governed by State / Federal Authority.

WE WILL NOT GIVE WARRANTY ON THE FOLLOWING :-

- 1** Bad Installation work by tradesman or other. Our determination is binding on this and we will not pass warranty unless it is proven beyond doubt that fault lies with the product. This has been bought about by plumbers not carrying out correct installation as in accordance with our instructions. i.e. using a liquid sealant in place of a 'Quality Thread Tape', or installing the Spring Guard upside down. The curve MUST always be at the Top, only straight end to be fitted to Spring Retainer.
- 2** Abuse of the product by the end user. Using the product outside of the design of the product.
- 3** Where a third party has decided to install or use one of our products outside the design of said product. Unless we have been involved in the decision we will not warrant or take back the product.
- 4** Resold or Used second hand product.

In the case of a genuine warranty we will carry out repair or replacement of the product by means of using a contractor or carry out the work ourselves. We will do our best to have the work done within 2-5 days if not sooner. However, when using a contractor we cannot determine the time, we are governed by them.

***Please confirm with Global Tapware for pricing of projects. This pricelist should be used as a guide only.**

Global Tapware Pty Ltd

W: www.globaltapware.com.au **E:** sales.info@globaltapware.com
P: +61 7 3855 2350 | **P:** 1300 85 25 15 (national calls only) | **F:** +61 7 3112 1916

STANDARD DECK MODELS



A A-SS



B B-SS



C C-SS



D D-SS



E



F

Cafe DECK MODELS



G



H



I



J



K



L

STANDARD WALL MODELS



M



N



O



P



Q



R

Cafe WALL MODELS



S



T



U



V

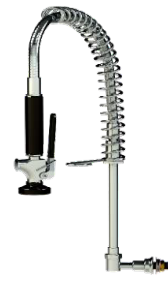

W



X

	Item	Pt. No.	RRP \$ (excl. GST)	WELS	Spout Size	Hole Size / Spacing	Height (approx.)
Deck - Standard Models	A	GF022100	\$ 794.65	6	nil	22mm	900 mm
	A-SS	GF022100-SS	\$ 854.65	6	nil	22mm	900 mm
	B	GF022506	\$ 967.57	3 / 6	6"	22mm	900 mm
		GF022512	"	3 / 6	12"	22mm	900 mm
	B-SS	GF022512-SS	\$ 1,127.57	3 / 6	12"	22mm	900 mm
		GF022514-SS	"	3 / 6	14"	22mm	900 mm
	C	GF032100	\$ 967.45	6	nil	32mm	900 mm
		C-SS	GF032100-SS	\$ 1,167.45	6	nil	32mm
	D	GF032506	\$ 1,097.58	3 / 6	6"	32mm	900 mm
		GF032512	"	3 / 6	12"	32mm	900 mm
D-SS		GF032512-SS	\$ 1,297.58	3 / 6	12"	32mm	900 mm
D-SS		GF032514-SS	"	3 / 6	14"	32mm	900 mm
Café - DECK	E	GF032100-C	\$ 937.34	6	nil	32mm	600 mm
	F	GF032506-C	\$ 1,056.72	3 / 6	6"	32mm	600 mm
GF032512-C		"	3 / 6	12"	32mm	600 mm	
Deck - Standard Models	G	GF042100	\$ 967.45	6	nil	22mm	900 mm
	H	GF042506	\$ 1,097.58	3 / 6	6"	22mm	900 mm
		GF042512	"	3 / 6	12"	22mm	900 mm
	I	GF062100	\$ 687.42	6	nil	22mm	900 mm
	J	GF062506	\$ 855.31	3 / 6	6"	22mm	900 mm
		GF062512	"	3 / 6	12"	22mm	900 mm
L	GF072100	\$ 967.45	6	nil	32mm / 110 -180	900 mm	
	GF072506	\$ 1,359.21	3 / 6	6"	32mm / 110 -180	900 mm	
		GF072512	"	3 / 6	12"	32mm / 110 -180	900 mm
Wall - Standard Models	M	GF112100	\$ 814.65	6	nil	22mm	900 mm
	M-SS	GF112100-SS	\$ 914.65	6	nil	22mm	900 mm
	N	GF112506	\$ 987.45	3 / 6	6"	22mm	900 mm
		GF112512	"	3 / 6	12"	22mm	900 mm
	N-SS	GF112512-SS	\$ 1,187.85	3 / 6	12"	22mm	900 mm
		GF152100	\$ 967.45	6	nil	22mm / 197 - 213	900 mm
	O-SS	GF152100-SS	\$ 1,067.45	6	nil	22mm / 197 - 213	900 mm
	P	GF152506	\$ 1,097.58	3 / 6	6"	22mm / 197 - 213	900 mm
		GF152512	"	3 / 6	12"	22mm / 197 - 213	900 mm
	P-SS	GF152512-SS	\$ 1,297.58	3 / 6	12"	22mm / 197 - 213	900 mm
P-SS-PL		GF152512-SS-PL	\$ 1,428.48	3 / 6	12"	22mm / 197 - 213	900 mm + Levers
P-SS	GF152514-SS	\$ 1,297.58	3 / 6	12"	22mm / 197 - 213	900 mm	
Q	GF162100	\$ 770.52	6	nil	22mm	900 mm	
R	GF162506	\$ 944.20	3 / 6	6"	22mm	900 mm	
	GF162512	"	3 / 6	12"	22mm	900 mm	
Café - WALL	S	GF112100-C	\$ 784.54	6	nil	22mm	600 mm
	T	GF112506-C	\$ 957.58	3 / 6	6"	22mm	600 mm
		GF112512-C	"	3 / 6	12"	22mm	600 mm
	U	GF152100-C	\$ 937.45	6	nil	22mm / 197 - 213	600 mm
	V	GF152506-C	\$ 1,067.58	3 / 6	6"	22mm / 197 - 213	600 mm
		GF152512-C	"	3 / 6	12"	22mm / 197 - 213	600 mm
W	GF162100-C	\$ 740.52	6	nil	22mm	600 mm	
X	GF162506-C	\$ 914.20	3 / 6	6"	22mm	600 mm	
	GF162512-C	"	3 / 6	12"	22mm	600 mm	

Note:-

- 1 - SS = Complete STAINLESS STEEL Unit/s, suitable for R.O. water applications
- 2 - A Shower Head for S/S units will be available soon in 2017



Global Tapware Pty Ltd

W: www.globaltapware.com.au **E:** sales.info@globaltapware.com
P: +61 7 3855 2350 | **P:** 1300 85 25 15 (national calls only) | **F:** +61 7 3112 1916

FISHER™

Hanging & Line-Retractor MODELS

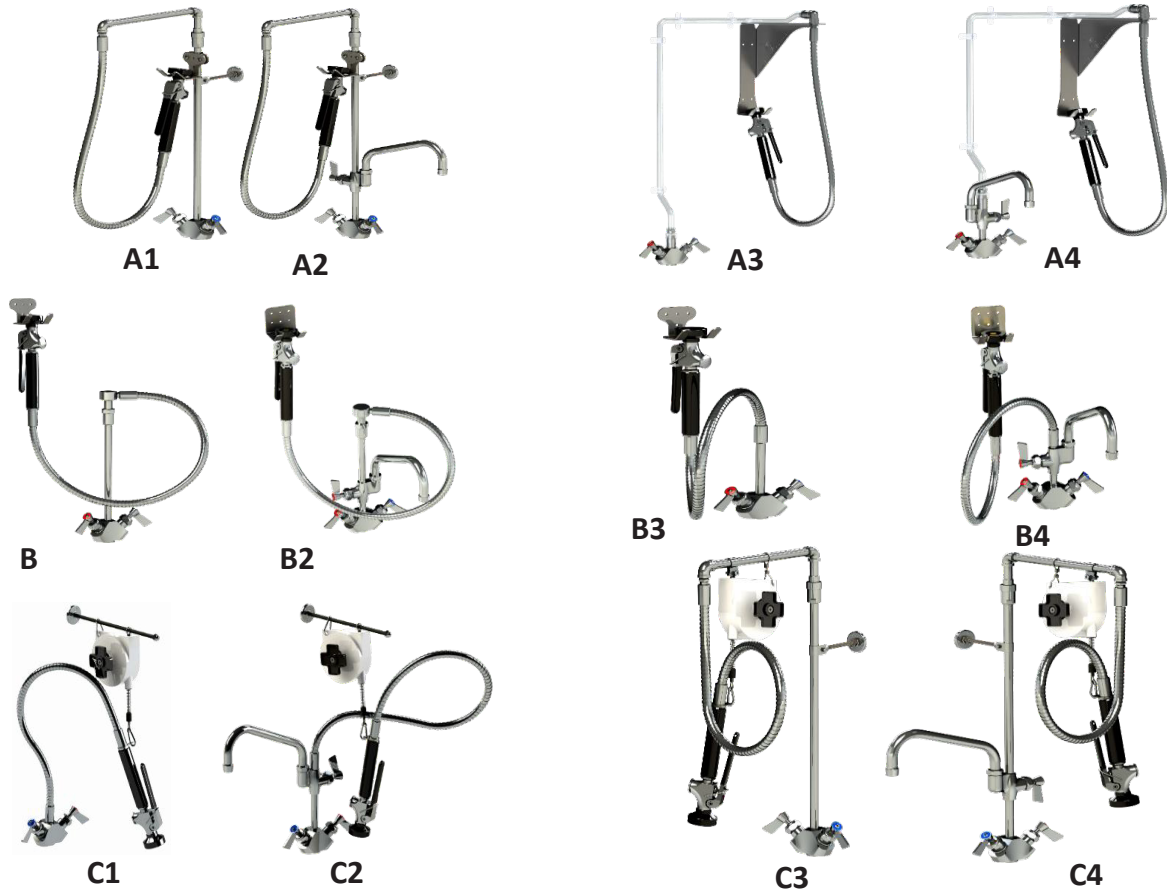

	Item	Pt. No.	RRP \$ (excl. GST)	WELS	Spout Size	Hole / Spacing	Height (approx.)
Swivel Arm	A1	GF032100-SAH	\$ 967.45	6	nil	32mm	750 mm
	A2	GF032506-SAH	\$ 1,097.58	3 / 6	6"	32mm	750 mm
		GF032512-SAH	\$ "	3 / 6	12"	32mm	750 mm
Wall Hang Bracket	A3	GF032100-HWB-H	\$ 967.45	6	nil	32mm	Variable
	A4	GF032506-HWB-H	\$ 1,097.58	3 / 6	6"	32mm	Variable
		GF032512-HWB-H	\$ "	3 / 6	12"	32mm	Variable
Wall Hook - Swivel	B1	GF032100-SH	\$ 857.45	6	nil	32mm	Variable
	B2	GF032506-SH	\$ 1,097.58	3 / 6	6"	32mm	Variable
		GF032512-SH	\$ "	3 / 6	12"	32mm	Variable
Wall Hook - Standard	B3	GF032100-H	\$ 797.45	6	nil	32mm	Variable
	B4	GF032506-H	\$ 927.58	3 / 6	6"	32mm	Variable
		GF032512-H	\$ "	3 / 6	12"	32mm	Variable
Line Retractable ARM - / - WALL	C1	GF032100-LRW	\$ 857.45	6	nil	32mm	Variable
	C2	GF032506-LRW	\$ 997.57	3 / 6	6"	32mm	Variable
		GF032512-LRW	\$ "	3 / 6	12"	32mm	Variable
	C3	GF032100-LRWQ	\$ 1,027.45	6	nil	32mm	750 mm
	C4	GF032506-LRWQ	\$ 1,197.57	3 / 6	6"	32mm	750 mm
GF032512-LRWQ		\$ "	3 / 6	12"	32mm	750 mm	



SUPERMARKET MODELS

Standard Deck Models

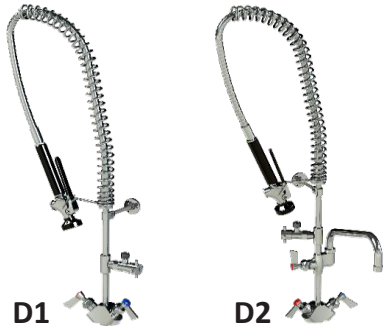

Cafe Deck Models



Standard Wall Models

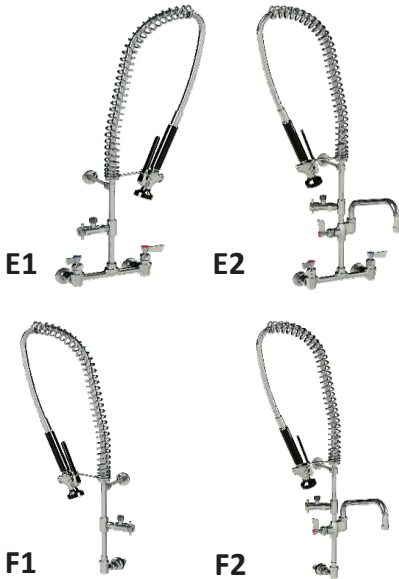

Cafe Wall Models



	Item	Pt. No.	RRP \$ (excl. GST)	WELS	Spout Size	Hole / Spacing	Height (approx.)
STANDARD DECK	D1	GF032100-SM	\$ 1,117.45	6	nil	32mm	900 mm
	D2	GF032506-SM	\$ 1,347.58	3 / 6	6"	32mm	900 mm
		GF032512-SM	\$ "	3 / 6	12"	32mm	900 mm
CAFÉ DECK	D3	GF032100-CSM	\$ 1,087.34	6	nil	32mm	600 mm
	D4	GF032506-CSM	\$ 1,186.52	3 / 6	6"	32mm	600 mm
		GF032512-CSM	\$ "	3 / 6	12"	32mm	600 mm
STANDARD WALL	E1	GF152100-SM	\$ 1,117.45	6	nil	22mm / 197 - 213	900 mm
	E2	GF152506-SM	\$ 1,347.58	3 / 6	6"	22mm / 197 - 213	900 mm
		GF152512-SM	\$ "	3 / 6	12"	22mm / 197 - 213	900 mm
CAFÉ WALL	E3	GF152100-CSM	\$ 1,087.34	6	nil	22mm / 197 - 213	600 mm
	E4	GF152506-CSM	\$ 1,186.52	3 / 6	6"	22mm / 197 - 213	600 mm
		GF152512-CSM	\$ "	3 / 6	12"	22mm / 197 - 213	600 mm
STANDARD WALL	F1	GF162100-SM	\$ 900.52	6	nil	22mm	900 mm
	F2	GF162506-SM	\$ 974.10	3 / 6	6"	22mm	900 mm
		GF162512-SM	\$ "	3 / 6	12"	22mm	900 mm
CAFÉ WALL	F3	GF162100-CSM	\$ 870.41	6	nil	22mm	600 mm
	F4	GF162506-CSM	\$ 1,044.09	3 / 6	6"	22mm	600 mm
		GF162512-CSM	\$ "	3 / 6	12"	22mm	600 mm



'STAINLESS'

STANDARD SPOUT DECK MODELS



A



B



C



D



E

STANDARD SPOUT WALL MODELS



F



G



H
CLEANERS SINK TAP



I

Item	Pt. No.	RRP \$ (excl. GST)	WELS	Spout Size	Hole Size / Spacing	SPOUT TYPE
------	---------	--------------------	------	------------	---------------------	------------

BENCH MOUNT TAPWARE

Single Deck Tap	A	GS02S3006	\$ 454.71	3	6"	22mm	STDD SWIVEL
		GS02S3008	\$ "	3	8"	22mm	"
		GS02S3010	\$ "	3	10"	22mm	"
		GS02S3012	\$ "	3	12"	22mm	"
		GS02S3014	\$ "	3	14"	22mm	"
Dual Deck Tap	B	GS03S3006	\$ 682.50	3	6"	32mm	STDD SWIVEL
		GS03S3008	\$ "	3	8"	32mm	"
		GS03S3010	\$ "	3	10"	32mm	"
		GS03S3012	\$ "	3	12"	32mm	"
		GS03S3014	\$ "	3	14"	32mm	"
Exposed Breach Tap	C	GS04S3006	\$ 682.50	3	6"	22mm / 206	STDD SWIVEL
		GS04S3008	\$ "	3	8"	22mm / 206	"
		GS04S3010	\$ "	3	10"	22mm / 206	"
		GS04S3012	\$ "	3	12"	22mm / 206	"
		GS04S3014	\$ "	3	14"	22mm / 206	"
Deck Outlet Only	D	GS06S3006	\$ 242.05	3	6"	22mm	STDD SWIVEL
		GS06S3008	\$ "	3	8"	22mm	"
		GS06S3010	\$ "	3	10"	22mm	"
		GS06S3012	\$ "	3	12"	22mm	"
		GS06S3014	\$ "	3	14"	22mm	"
Adjustable Hidden Breach	E	GS07S3006	\$ 727.60	3	6"	32mm / Variable	STDD SWIVEL
		GS07S3008	\$ "	3	8"	32mm / Variable	"
		GS07S3010	\$ "	3	10"	32mm / Variable	"
		GS07S3012	\$ "	3	12"	32mm / Variable	"
		GS07S3014	\$ "	3	14"	32mm / Variable	"

WALLMOUNT TAPWARE

Single Wall Tap	F	GS11S3006	\$ 682.50	3	6"	22mm	STDD SWIVEL
		GS11S3008	\$ "	3	8"	22mm	"
		GS11S3010	\$ "	3	10"	22mm	"
		GS11S3012	\$ "	3	12"	22mm	"
		GS11S3014	\$ "	3	14"	22mm	"
Exposed Wall Tap	G	GS15S3006	\$ 682.50	3	6"	22mm / 197 - 213	STDD SWIVEL
		GS15S3008	\$ "	3	8"	22mm / 197 - 213	"
		GS15S3010	\$ "	3	10"	22mm / 197 - 213	"
		GS15S3012	\$ "	3	12"	22mm / 197 - 213	"
		GS15S3014	\$ "	3	14"	22mm / 197 - 213	"
Cleaners Sink	H	GS15S3012-CS	\$ 780.65	3	12"	22mm / 197 - 213	STDD SWIVEL
		GS15S3014-CS	\$ "	3	14"	22mm / 197 - 213	"
Wall Outlet Only	I	GS16S3006	\$ 273.40	3	6"	22mm	STDD SWIVEL
		GS16S3008	\$ "	3	8"	22mm	"
		GS16S3010	\$ "	3	10"	22mm	"
		GS16S3012	\$ "	3	12"	22mm	"
		GS16S3014	\$ "	3	14"	22mm	"



'STAINLESS'

Gooseneck / KETTLE SPOUT DECK MODELS



Gooseneck / KETTLE SPOUT WALL MODELS



Item	Pt. No.	RRP \$ (excl. GST)	WELS	Spout Size	Hole Size / Spacing	SPOUT TYPE
------	---------	--------------------	------	------------	---------------------	------------

BENCH MOUNT TAPWARE

Category	Item	Pt. No.	RRP \$ (excl. GST)	WELS	Spout Size	Hole Size / Spacing	SPOUT TYPE				
Single Deck Tap	A	Gooseneck Swivel or Fixed Spout		3	6"	22mm	Gooseneck Swvl / Fixed				
		GS02S3106	\$ 464.71					3	12"	22mm	"
		GS02S3112	\$ 464.71								
	Kettle / Wok Filler Tap		3	18"	22mm	Dble Swivel w/- End Tap					
B	GS02S3218	\$ 750.18									
Dual Deck Tap	C	Gooseneck Swivel or Fixed Spout		3	6"	22mm	Gooseneck Swivel / Fixed				
		GS03S3006	\$ 692.50					3	12"	22mm	"
		GS03S3012	\$ 692.50								
	Kettle / Wok Filler Tap		3	18"	22mm	Double Swivel w/- End Ta					
D	GS03S3218	\$ 822.50									
Exposed Breach Tap	E	Gooseneck Swivel or Fixed Spout		3	6"	22mm / 206	Gooseneck Swivel / Fixed				
		GS04S3106	\$ 692.50					3	12"	22mm / 206	"
		GS04S3112	\$ 692.50								
	Kettle / Wok Filler Tap		3	18"	22mm / 206	Double Swivel w/- End Ta					
F	GS04S3218	\$ 822.50									
Deck Outlet Only	G	Gooseneck Swivel or Fixed Spout		3	6"	22mm	Gooseneck Swivel / Fixed				
		GS06S3106	\$ 252.60					3	12"	22mm	"
		GS06S3112	\$ 252.60								
	Kettle / Wok Filler Tap		3	18"	22mm	Double Swivel w/- End Ta					
H	GS06S3218	\$ 564.24									

WALL MOUNT TAPWARE

Category	Item	Pt. No.	RRP \$ (excl. GST)	WELS	Spout Size	Hole Size / Spacing	SPOUT TYPE				
Single Wall Tap	I	Gooseneck Swivel or Fixed Spout		3	6"	22mm	Gooseneck Swivel / Fixed				
		GS11S3106	\$ 494.70					3	12"	22mm	"
		GS11S3112	\$ 494.70								
	Kettle / Wok Filler Tap		3	18"	22mm	Double Swivel w/- End Ta					
J	GS11S3218	\$ 770.13									
Exposed Wall Tap	K	Gooseneck Swivel or Fixed Spout		3	6"	22mm / 197 - 213	Gooseneck Swivel / Fixed				
		GS15S3106	\$ 692.50					3	12"	22mm / 197 - 213	"
		GS15S3112	\$ 692.50								
	Kettle / Wok Filler Tap		3	18"	22mm / 197 - 213	Double Swivel w/- End Ta					
L	GS15S3218	\$ 909.86									
Wall Outlet Only	M	Gooseneck Swivel or Fixed Spout		3	6"	22mm	Gooseneck Swivel / Fixed				
		GS16S3106	\$ 282.40					3	12"	22mm	"
		GS16S3112	\$ 282.40								
	Kettle / Wok Filler Tap		3	18"	22mm	Double Swivel w/- End Ta					
N	GS16S3218	\$ 631.57									



'Rinsemaid'TM

STANDARD DECK MODELS

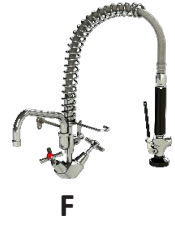

Cafe DECK MODELS



STANDARD WALL MODELS



	Item	Pt. No.	RRP \$ (excl. GST)	WELS	Spout Size	Hole Size / Spacing	Height (approx.)
Deck - Standard Models	A	GRM012100	\$ 889.28	6	nil	22mm	900 mm
	B	GRM012506	\$ 1,043.66	3 / 6	6"	22mm	900 mm
		GRM012512	\$ "	3 / 6	12"	22mm	900 mm
	C	GRM032100	\$ 799.10	6	nil	32mm	900 mm
D	GRM032506	\$ 889.50	3 / 6	6"	32mm	900 mm	
	GRM032512	\$ "	3 / 6	12"	32mm	900 mm	
Café - DECK	E	GRM032100-C	\$ 764.34	6	nil	32mm	600 mm
	F	GRM032506-C	\$ 863.22	3 / 6	6"	32mm	600 mm
		GRM032512-C	\$ "	3 / 6	12"	32mm	600 mm
Deck - Standard Models	G	GRM052100	\$ 1,039.61	6	nil	22mm / 120 - 280	900 mm
	H	GRM052506	\$ 1,193.99	3 / 6	6"	22mm / 120 - 280	900 mm
		GRM052512	\$ "	3 / 6	12"	22mm / 120 - 280	900 mm
	I	GRM062100	\$ 626.31	6	nil	22mm	900 mm
J	GRM062506	\$ 780.69	3 / 6	6"	22mm	900 mm	
	GRM062512	\$ "	3 / 6	12"	22mm	900 mm	
Wall - Standard Models	M	GRM112100	\$ 814.65	6	nil	22mm	900 mm
	N	GRM112506	\$ 987.45	3 / 6	6"	22mm	900 mm
		GRM112512	\$ "	3 / 6	12"	22mm	900 mm
	O	GRM132100	\$ 666.31	6	nil	22mm / 120 - 280	VARIABLE
	P	GRM132506	\$ 840.69	3 / 6	6"	22mm / 120 - 280	VARIABLE
		GRM132512	\$ "	3 / 6	12"	22mm / 120 - 280	VARIABLE
	Q	GRM142100	\$ 1,145.50	6	nil	22mm / 120 - 280	900 mm
	R	GRM142506	\$ 1,296.40	3 / 6	6"	22mm / 120 - 280	900 mm
		GRM142512	\$ "	3 / 6	12"	22mm / 120 - 280	900 mm
	S	GRM152100	\$ 1,215.26	6	nil	22mm / 120 - 280	900 mm
T	GRM152506	\$ 1,369.54	3 / 6	6"	22mm / 120 - 280	900 mm	
	GRM152512	\$ "	3 / 6	12"	22mm / 120 - 280	900 mm	
U	GRM162100	\$ 662.31	6	nil	22mm	900 mm	
V	GRM162506	\$ 866.99	3 / 6	6"	22mm	900 mm	
	GRM162512	\$ "	3 / 6	12"	22mm	900 mm	



Global Tapware Pty Ltd

W: www.globaltapware.com.au **E:** sales.info@globaltapware.com
P: +61 7 3855 2350 | **P:** 1300 85 25 15 (national calls only) | **F:** +61 7 3112 1916

'Easy CLEAN'

STANDARD SPOUT DECK MODELS



A



B

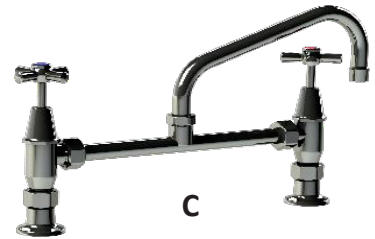

C



D

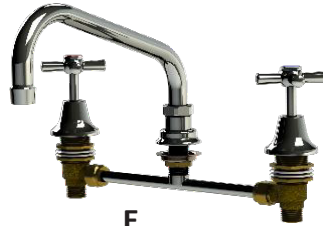

E



F

STANDARD SPOUT WALL MODELS



G



H



H-1



I



J



K

Item	Pt. No.	RRP \$ (excl. GST)	WELS	Spout Size	Hole Size / Spacing	SPOUT TYPE
------	---------	--------------------	------	------------	---------------------	------------

BENCH MOUNT TAPWARE

Single Deck Tap	A	GEC01S3006	\$ 432.00	3	6"	22mm	Standard Swivel
		GEC01S3008	\$ "	3	8"	22mm	"
		GEC01S3010	\$ "	3	10"	22mm	"
		GEC01S3012	\$ "	3	12"	22mm	"
		GEC01S3014	\$ "	3	14"	22mm	"
Dual Deck Tap	B	GEC03S3006	\$ 384.20	3	6"	32mm	Standard Swivel
		GEC03S3008	\$ "	3	8"	32mm	"
		GEC03S3010	\$ "	3	10"	32mm	"
		GEC03S3012	\$ "	3	12"	32mm	"
		GEC03S3014	\$ "	3	14"	32mm	"
Exposed Breach Tap	C	GEC05S3006	\$ 546.75	3	6"	22mm / 120 - 280	Standard Swivel
		GEC05S3008	\$ "	3	8"	22mm / 120 - 280	"
		GEC05S3010	\$ "	3	10"	22mm / 120 - 280	"
		GEC05S3012	\$ "	3	12"	22mm / 120 - 280	"
		GEC05S3014	\$ "	3	14"	22mm / 120 - 280	"
Deck Outlet Only	D	GEC06S3006	\$ 252.91	3	6"	22mm	Standard Swivel
		GEC06S3008	\$ "	3	8"	22mm	"
		GEC06S3010	\$ "	3	10"	22mm	"
		GEC06S3012	\$ "	3	12"	22mm	"
		GEC06S3014	\$ "	3	14"	22mm	"
Adjustable Hidden Breach	E	GEC07S3006	\$ 205.60	3	6"	32mm / 120 - 280	Standard Swivel
		GEC07S3008	\$ "	3	8"	32mm / 120 - 280	"
		GEC07S3010	\$ "	3	10"	32mm / 120 - 280	"
		GEC07S3012	\$ "	3	12"	32mm / 120 - 280	"
		GEC07S3014	\$ "	3	14"	32mm / 120 - 280	"
Sink Tap- Hidden Breach	F	GEC08S3006	\$ 180.60	3	6"	32mm	Standard Swivel
		GEC08S3008	\$ "	3	8"	32mm	"
		GEC08S3010	\$ "	3	10"	32mm	"
		GEC08S3012	\$ "	3	12"	32mm	"
		GEC08S3014	\$ "	3	14"	32mm	"

WALL MOUNT TAPWARE

Single Wall Tap	G	GEC11S3006	\$ 444.00	3	6"	22mm	Standard Swivel
		GEC11S3008	\$ "	3	8"	22mm	"
		GEC11S3010	\$ "	3	10"	22mm	"
		GEC11S3012	\$ "	3	12"	22mm	"
		GEC11S3014	\$ "	3	14"	22mm	"
WALL STOPS	H	GEC13S3006	\$ 246.00	3	6"	22mm / Variable	Standard Swivel
		GEC13S3012	\$ "	3	12"	22mm / Variable	"
		GEC13S3014	\$ "	3	14"	22mm / Variable	"
		GEC13S3014	\$ "	3	14"	22mm / Variable	"
	H-1	GEC13SLA225	\$ 68.00		225mm	22mm / Variable	Swivel Laundry Arm
Exposed Wall Tap -straight	I	GEC14S3006	\$ 546.75	3	6"	22mm / 120 - 280	Standard Swivel
		GEC14S3008	\$ "	3	8"	22mm / 120 - 280	"
		GEC14S3010	\$ "	3	10"	22mm / 120 - 280	"
		GEC14S3012	\$ "	3	12"	22mm / 120 - 280	"
		GEC14S3014	\$ "	3	14"	22mm / 120 - 280	"
Exposed Wall Tap -90d Elbow	J	GEC15S3006	\$ 709.16	3	6"	22mm / 120 - 280	Standard Swivel
		GEC15S3008	\$ "	3	8"	22mm / 120 - 280	"
		GEC15S3010	\$ "	3	10"	22mm / 120 - 280	"
		GEC15S3012	\$ "	3	12"	22mm / 120 - 280	"
		GEC15S3014	\$ "	3	14"	22mm / 120 - 280	"
Wall Outlet Only	K	GEC16S3006	\$ 195.30	3	6"	22mm	Standard Swivel
		GEC16S3008	\$ "	3	8"	22mm	"
		GEC16S3010	\$ "	3	10"	22mm	"
		GEC16S3012	\$ "	3	12"	22mm	"
		GEC16S3014	\$ "	3	14"	22mm	"



'Easy CLEAN'

GOOSENECK SPOUT - Swivel / Fixed
KETTLE / POT FILLER SPOUT MODELS



A1 & A2



A3



B1 & B2



B3



C1 & C2

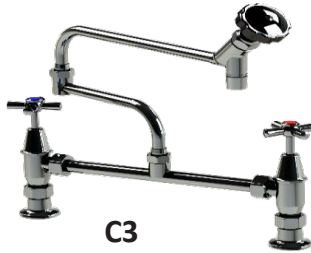

C3



D1



E1 & E2



E3



F1 & F2



F3



G1 & G2



G3



H1 & H2

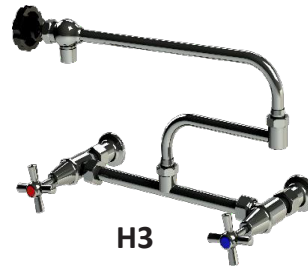

H3



I1 & I2



I3

Item	Pt. No.	RRP \$ (excl. GST)	WELS	Spout Size	Hole Size / Spacing	SPOUT TYPE
------	---------	--------------------	------	------------	---------------------	------------

BENCH MOUNT TAPWARE

Single Deck Tap	A1	GEC01S3106 GEC01S3112	\$ 453.00 \$ "	3 3	6" 12"	22mm 22mm	Gooseneck Swivel "
	A2	GEC01S3206 GEC01S3212	\$ 518.46 \$ "	3 3	6" 12"	22mm 22mm	Gooseneck Fixed "
	A3	GEC01S3218	\$ 583.00	3	18"	22mm	Dble Swivel E/Tap
Dual Deck Tap	B1	GEC03S3106 GEC03S3112	\$ 487.00 \$ "	3 3	6" 12"	22mm 22mm	Gooseneck Swivel "
	B2	GEC03S3206 GEC03S3212	\$ 487.00 \$ "	3 3	6" 12"	22mm 22mm	Gooseneck Fixed "
	B3	GEC03S3218	\$ 565.65	3	18"	22mm	Dble Swivel End Tap
Exposed Breach Tap	C1	GEC05S3106 GEC05S3112	\$ 567.50 \$ "	3 3	6" 12"	22mm / 120 - 280 22mm / 120 - 280	Gooseneck Swivel "
	C2	GEC05S3206 GEC05S3212	\$ 567.50 \$ "	3 3	6" 12"	22mm / 120 - 280 22mm / 120 - 280	Gooseneck Fixed "
	C3	GEC05S3218	\$ 697.50	3	18"	22mm / 120 - 280	Dble Swivel End Tap
Basin Tap	D1	GEC07S3106	\$ 235.00	3	6"	22mm / VARIABLE	Gooseneck Swivel
Deck Outlet Only	E1	GEC06S3106 GEC06S3112	\$ 255.20 \$ "	3 3	6" 12"	22mm 22mm	Gooseneck Swivel "
	E2	GEC06S3206 GEC06S3212	\$ 255.20 \$ "	3 3	6" 12"	22mm 22mm	Gooseneck Fixed "
	E3	GEC06S3218	\$ 385.20	3	18"	22mm	Dble Swivel End Tap

WALL MOUNT TAPWARE

Single Wall Tap	F1	GEC11S3106 GEC11S3112	\$ 495.50 \$ "	3 3	6" 12"	22mm 22mm	Gooseneck Swivel "
	F2	GEC11S3206 GEC11S3212	\$ 505.00 \$ "	3 3	6" 12"	22mm 22mm	Gooseneck Fixed "
	F3	GEC11S3218	\$ 635.50	3	18"	22mm	Dble Swivel E/Tap
WALL STOPS	G1	GEC13S3106 GEC13S3112	\$ 279.70 \$ "	3 3	6" 12"	22mm 22mm	Gooseneck Swivel "
	G2	GEC13S3206 GEC13S3212	\$ 279.70 \$ "	3 3	6" 12"	22mm 22mm	Gooseneck Fixed "
	G3	GEC13S3218	\$ 406.50	3	18"	22mm	Dble Swivel End Tap
Exposed Wall Tap	H1	GEC14S3106 GEC14S3112	\$ 576.75 \$ "	3 3	6" 12"	22mm / 120 - 280 22mm / 120 - 280	Gooseneck Swivel "
	H2	GEC14S3206 GEC14S3212	\$ 576.75 \$ "	3 3	6" 12"	22mm / 120 - 280 22mm / 120 - 280	Gooseneck Fixed "
	H3	GEC14S3218	\$ 706.75	3	18"	22mm / 120 - 280	Dble Swivel End Tap
Wall Outlet Only	I1	GEC16S3106 GEC16S3112	\$ 195.30 \$ "	3 3	6" 12"	22mm 22mm	Gooseneck Swivel "
	I2	GEC16S3206 GEC16S3212	\$ 225.30 \$ "	3 3	6" 12"	22mm 22mm	Gooseneck Fixed "
	I3	GEC16S3218	\$ 428.60	3	18"	22mm	Dble Swivel End Tap



Global Tapware Pty Ltd

W: www.globaltapware.com.au E: sales.info@globaltapware.com
P: +61 7 3855 2350 | P: 1300 85 25 15 (national calls only) | F: +61 7 3112 1916

'Q - Standard Range'

1 Pin Handle / Jumper Valve R.A.**

STANDARD SPOUT DECK MODELS



A



B



C



D

STANDARD SPOUT WALL MODELS



E



F



G



H



I

**R.A. = Rapid Action = Rapid Rising Spindle = 1/4 Turn

Item	Pt. No.	RRP \$ (excl. GST)	WELS	Spout Size	Hole Size / Spacing	SPOUT TYPE
------	---------	--------------------	------	------------	---------------------	------------

BENCH MOUNT TAPWARE

Single Deck Tap	A	GQ01S3006	\$ 477.00	3	6"	22mm	STDD SWIVEL
		GQ01S3008	\$ "	3	8"	22mm	"
		GQ01S3010	\$ "	3	10"	22mm	"
		GQ01S3012	\$ "	3	12"	22mm	"
		GQ01S3014	\$ "	3	14"	22mm	"
Dual Deck Tap	B	GQ03S3006	\$ 477.00	3	6"	32mm	STDD SWIVEL
		GQ03S3008	\$ "	3	8"	32mm	"
		GQ03S3010	\$ "	3	10"	32mm	"
		GQ03S3012	\$ "	3	12"	32mm	"
		GQ03S3014	\$ "	3	14"	32mm	"
Exposed Breach Tap	C	GQ05S3006	\$ 826.00	3	6"	22mm / 120 - 280	STDD SWIVEL
		GQ05S3008	\$ "	3	8"	22mm / 120 - 280	"
		GQ05S3010	\$ "	3	10"	22mm / 120 - 280	"
		GQ05S3012	\$ "	3	12"	22mm / 120 - 280	"
		GQ05S3014	\$ "	3	14"	22mm / 120 - 280	"
Deck Outlet Only	D	GQ06S3006	\$ 252.91	3	6"	22mm	STDD SWIVEL
		GQ06S3008	\$ "	3	8"	22mm	"
		GQ06S3010	\$ "	3	10"	22mm	"
		GQ06S3012	\$ "	3	12"	22mm	"
		GQ06S3014	\$ "	3	14"	22mm	"

WALL MOUNT TAPWARE

Single Wall Tap	E	GQ11S3006	\$ 464.00	3	6"	22mm	STDD SWIVEL
		GQ11S3008	\$ "	3	8"	22mm	"
		GQ11S3010	\$ "	3	10"	22mm	"
		GQ11S3012	\$ "	3	12"	22mm	"
		GQ11S3014	\$ "	3	14"	22mm	"
WALL STOPS	F	GQ13S3006	\$ 300.00	3	6"	22mm / Variable	STDD SWIVEL
		GQ13S3008	\$ "	3	8"	22mm / Variable	"
		GQ13S3010	\$ "	3	10"	22mm / Variable	"
		GQ13S3012	\$ "	3	12"	22mm / Variable	"
		GQ13S3014	\$ "	3	14"	22mm / Variable	"
Exposed Wall Tap -straight	G	GQ14S3006	\$ 826.00	3	6"	22mm / 120 - 280	STDD SWIVEL
		GQ14S3008	\$ "	3	8"	22mm / 120 - 280	"
		GQ14S3010	\$ "	3	10"	22mm / 120 - 280	"
		GQ14S3012	\$ "	3	12"	22mm / 120 - 280	"
		GQ14S3014	\$ "	3	14"	22mm / 120 - 280	"
Exposed Wall Tap -90d	H	GQ15S3006	\$ 866.00	3	6"	22mm / 120 - 280	STDD SWIVEL
		GQ15S3008	\$ "	3	8"	22mm / 120 - 280	"
		GQ15S3010	\$ "	3	10"	22mm / 120 - 280	"
		GQ15S3012	\$ "	3	12"	22mm / 120 - 280	"
		GQ15S3014	\$ "	3	14"	22mm / 120 - 280	"
Wall Outlet Only	I	GQ16S3006	\$ 278.20	3	6"	22mm	STDD SWIVEL
		GQ16S3008	\$ "	3	8"	22mm	"
		GQ16S3010	\$ "	3	10"	22mm	"
		GQ16S3012	\$ "	3	12"	22mm	"
		GQ16S3014	\$ "	3	14"	22mm	"

**Gooseneck & Kettle / Wok Filler Spouts are available for the 'Q' Range.
Ask us for a price.**



Global Tapware Pty Ltd

W: www.globaltapware.com.au **E:** sales.info@globaltapware.com
P: +61 7 3855 2350 | **P:** 1300 85 25 15 (national calls only) | **F:** +61 7 3112 1916

'Q-Junior School- Range'

3 Pin Handle / Jumper Valve R.A. **

STANDARD SPOUT DECK MODELS



A



B



B1

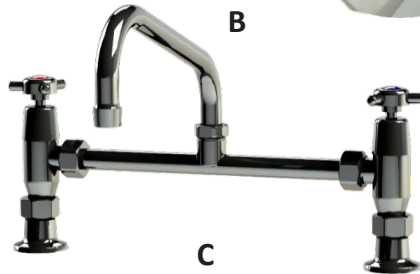

C

STANDARD SPOUT WALL MODELS



D



E

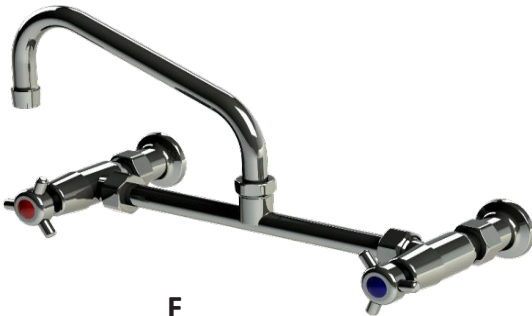

F

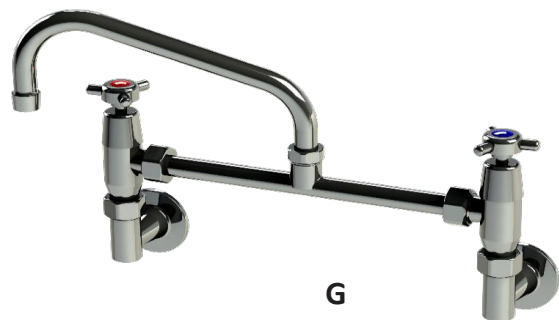

G

**R.A. = Rapid Action = Rapid Rising Spindle = 1/4 Turn

Item	Pt. No.	RRP \$ (excl. GST)	WELS	Spout Size	Hole Size / Spacing	SPOUT TYPE
------	---------	--------------------	------	------------	---------------------	------------

BENCH MOUNT TAPWARE

Single Deck Tap	A	GQ01S3006-JS	\$ 497.00	3	6"	22mm	STDD SWIVEL
		GQ01S3008-JS	"	3	8"	22mm	"
		GQ01S3010-JS	"	3	10"	22mm	"
		GQ01S3012-JS	"	3	12"	22mm	"
		GQ01S3014-JS	"	3	14"	22mm	"
Dual Deck Tap	B	GQ03S3006-JS	\$ 497.00	3	6"	32mm	STDD SWIVEL
		GQ03S3008-JS	"	3	8"	32mm	"
		GQ03S3010-JS	"	3	10"	32mm	"
		GQ03S3012-JS	"	3	12"	32mm	"
		GQ03S3014-JS	"	3	14"	32mm	"
	B1	GQ03S3106-JS	\$ 507.50	3	6"	32mm	Gooseneck SWIVEL
		GQ03S3112-JS	"	3	12"	32mm	"
Exposed Breach Tap	C	GQ05S3006-JS	\$ 846.00	3	6"	22mm / 120 - 280	STDD SWIVEL
		GQ05S3008-JS	"	3	8"	22mm / 120 - 280	"
		GQ05S3010-JS	"	3	10"	22mm / 120 - 280	"
		GQ05S3012-JS	"	3	12"	22mm / 120 - 280	"
		GQ05S3014-JS	"	3	14"	22mm / 120 - 280	"

WALL MOUNT TAPWARE

Single Wall Tap	D	GQ11S3006-JS	\$ 484.00	3	6"	22mm	STDD SWIVEL
		GQ11S3008-JS	"	3	8"	22mm	"
		GQ11S3010-JS	"	3	10"	22mm	"
		GQ11S3012-JS	"	3	12"	22mm	"
		GQ11S3014-JS	"	3	14"	22mm	"
WALL STOPS	E	GQ13S3006-JS	\$ 320.00	3	6"	22mm / Variable	STDD SWIVEL
		GQ13S3008-JS	"	3	8"	22mm / Variable	"
		GQ13S3010-JS	"	3	10"	22mm / Variable	"
		GQ13S3012-JS	"	3	12"	22mm / Variable	"
		GQ13S3014-JS	"	3	14"	22mm / Variable	"
Exposed Wall Tap - straight	F	GQ14S3006-JS	\$ 846.00	3	6"	22mm / 120 - 280	STDD SWIVEL
		GQ14S3008-JS	"	3	8"	22mm / 120 - 280	"
		GQ14S3010-JS	"	3	10"	22mm / 120 - 280	"
		GQ14S3012-JS	"	3	12"	22mm / 120 - 280	"
		GQ14S3014-JS	"	3	14"	22mm / 120 - 280	"
Exposed Wall Tap - 90 Degree Elbow	G	GQ15S3006-JS	\$ 886.00	3	6"	22mm / 120 - 280	STDD SWIVEL
		GQ15S3008-JS	"	3	8"	22mm / 120 - 280	"
		GQ15S3010-JS	"	3	10"	22mm / 120 - 280	"
		GQ15S3012-JS	"	3	12"	22mm / 120 - 280	"
		GQ15S3014-JS	"	3	14"	22mm / 120 - 280	"

NOTE:- Gooseneck & Kettle / Pot Filler Spouts are available for the 'Q-Quarter Turn Models. Ask for price.



Global Tapware Pty Ltd

W: www.globaltapware.com.au **E:** sales.info@globaltapware.com
P: +61 7 3855 2350 | **P:** 1300 85 25 15 (national calls only) | **F:** +61 7 3112 1916

'Q-Disable-Lever Range'

Lever Handle / Jumper Valve R.A. **

STANDARD SPOUT DECK MODELS.

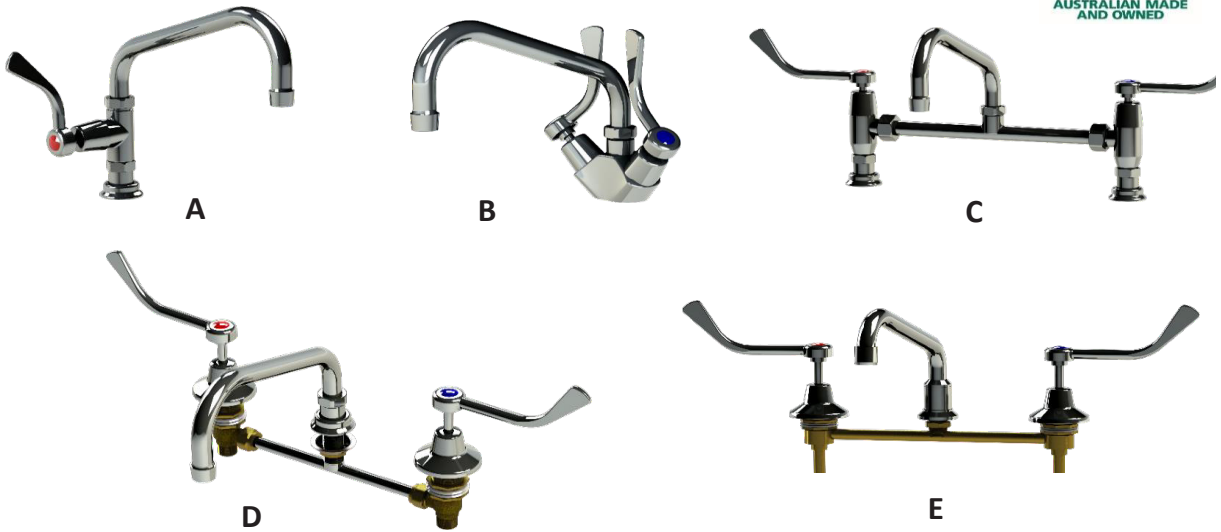

STANDARD SPOUT WALL MODELS

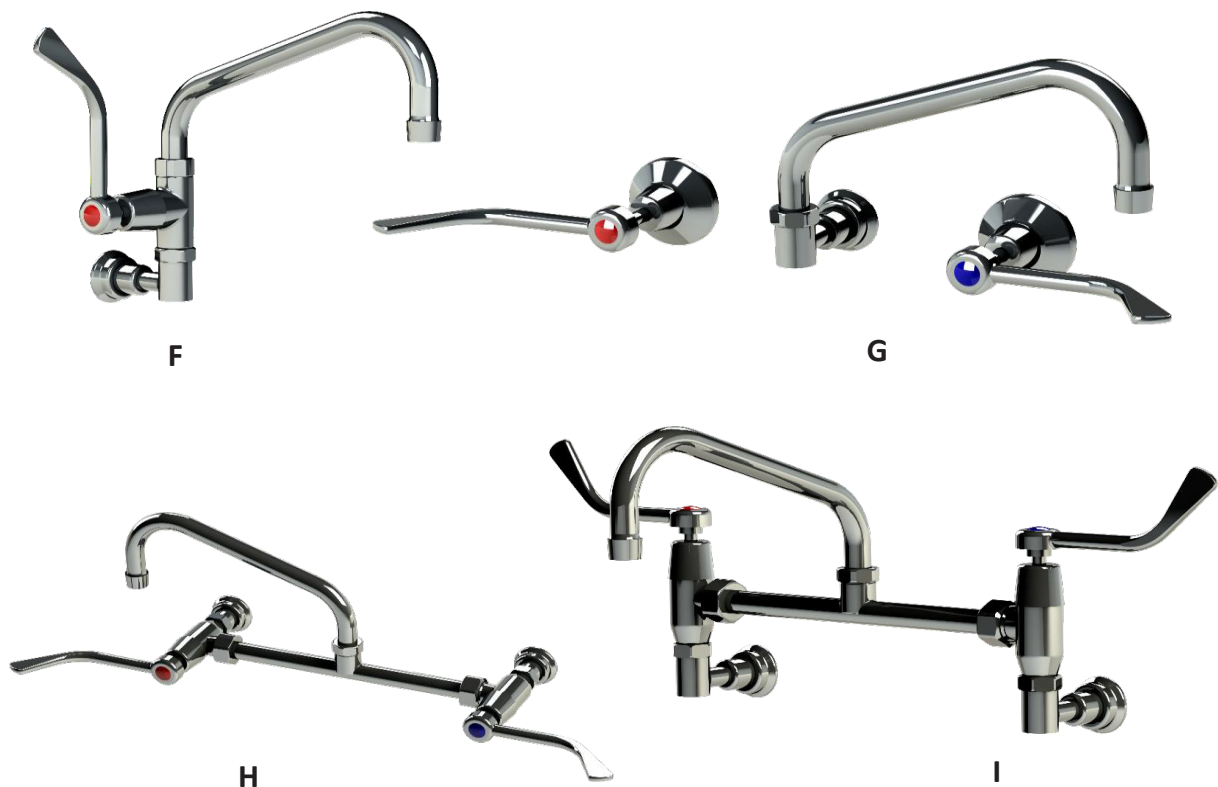

**R.A. = Rapid Action = Rapid Rising Spindle = 1/4 Turn

Item	Pt. No.	RRP \$ (excl. GST)	WELS	Spout Size	Hole Size / Spacing	SPOUT TYPE
------	---------	--------------------	------	------------	---------------------	------------

BENCH MOUNT TAPWARE

Lever Sizes- 'L1'= 115mm / 'L2' = 150mm / 'L3' = 180mm... Change 'END CODE' to suit.

Single Deck Tap	A	GQ01S3006-L2	\$ 497.00	3	6"	22mm	Standard Swivel
		GQ01S3008-L2	\$ "	3	8"	22mm	"
		GQ01S3010-L2	\$ "	3	10"	22mm	"
		GQ01S3012-L2	\$ "	3	12"	22mm	"
		GQ01S3014-L2	\$ "	3	14"	22mm	"
Dual Deck Tap Non Changeable lever size	B	GQ03S3006-L1	\$ 497.00	3	6"	32mm	Standard Swivel
		GQ03S3008-L1	\$ "	3	8"	32mm	"
		GQ03S3010-L1	\$ "	3	10"	32mm	"
		GQ03S3012-L1	\$ "	3	12"	32mm	"
		GQ03S3014-L1	\$ "	3	14"	32mm	"
Exposed Breach Tap	C	GQ05S3006-L2	\$ 846.00	3	6"	22mm / 120 - 280	Standard Swivel
		GQ05S3008-L2	\$ "	3	8"	22mm / 120 - 280	"
		GQ05S3010-L2	\$ "	3	10"	22mm / 120 - 280	"
		GQ05S3012-L2	\$ "	3	12"	22mm / 120 - 280	"
		GQ05S3014-L2	\$ "	3	14"	22mm / 120 - 280	"
Hidden Breach Tap	D	GQ07S3006-L2	\$ 846.00	3	6"	22mm / 120 - 280	Standard Swivel
		GQ07S3008-L2	\$ "	3	8"	22mm / 120 - 280	"
		GQ07S3010-L2	\$ "	3	10"	22mm / 120 - 280	"
		GQ07S3012-L2	\$ "	3	12"	22mm / 120 - 280	"
		GQ07S3014-L2	\$ "	3	14"	22mm / 120 - 280	"
Sink- Fixed Breach Tap	E	GQ08S3006-L2	\$ 846.00	3	6"	22mm / 120 - 280	Standard Swivel
		GQ08S3008-L2	\$ "	3	8"	22mm / 120 - 280	"
		GQ08S3010-L2	\$ "	3	10"	22mm / 120 - 280	"
		GQ08S3012-L2	\$ "	3	12"	22mm / 120 - 280	"
		GQ08S3014-L2	\$ "	3	14"	22mm / 120 - 280	"

WALL MOUNT TAPWARE

Single Wall Tap	F	GQ11S3006-L2	\$ 484.00	3	6"	22mm	Standard Swivel
		GQ11S3008-L2	\$ "	3	8"	22mm	"
		GQ11S3010-L2	\$ "	3	10"	22mm	"
		GQ11S3012-L2	\$ "	3	12"	22mm	"
		GQ11S3014-L2	\$ "	3	14"	22mm	"
WALL STOPS	G	GQ13S3006-L2	\$ 320.00	3	6"	22mm / Variable	Standard Swivel
		GQ13S3008-L2	\$ "	3	8"	22mm / Variable	"
		GQ13S3010-L2	\$ "	3	10"	22mm / Variable	"
		GQ13S3012-L2	\$ "	3	12"	22mm / Variable	"
		GQ13S3014-L2	\$ "	3	14"	22mm / Variable	"
Exposed Wall Tap - straight	H	GQ14S3006-L2	\$ 846.00	3	6"	22mm / 120 - 280	Standard Swivel
		GQ14S3008-L2	\$ "	3	8"	22mm / 120 - 280	"
		GQ14S3010-L2	\$ "	3	10"	22mm / 120 - 280	"
		GQ14S3012-L2	\$ "	3	12"	22mm / 120 - 280	"
		GQ14S3014-L2	\$ "	3	14"	22mm / 120 - 280	"
Exposed Wall Tap -90d	I	GQ15S3006-L2	\$ 886.00	3	6"	22mm / 120 - 280	Standard Swivel
		GQ15S3008-L2	\$ "	3	8"	22mm / 120 - 280	"
		GQ15S3010-L2	\$ "	3	10"	22mm / 120 - 280	"
		GQ15S3012-L2	\$ "	3	12"	22mm / 120 - 280	"
		GQ15S3014-L2	\$ "	3	14"	22mm / 120 - 280	"

NOTE:-

Gooseneck & Kettle / Wok Filler Spouts are available for the 'Q' Range.
Ask us for a price.



Global Tapware Pty Ltd

W: www.globaltapware.com.au E: sales.info@globaltapware.com
P: +61 7 3855 2350 | P: 1300 85 25 15 (national calls only) | F: +61 7 3112 1916

'HandZfree™ Range'

Electronic / Battery Operated Taps

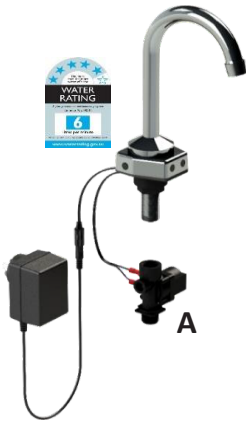

A

A-BAT



B

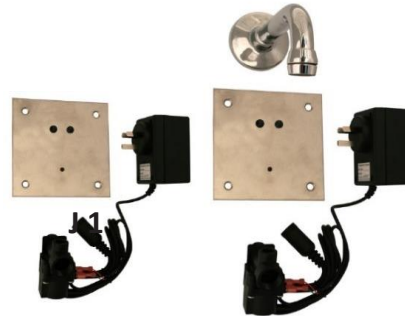

C

D

PUSH / KNEE Type Taps & Basins



E

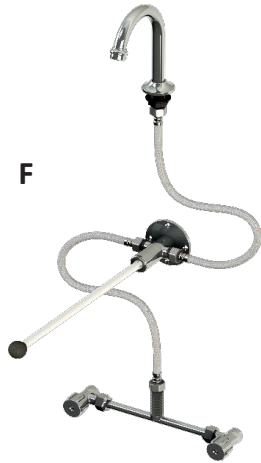

F



G

S/S FOOT / KNEE Type Valves



H



I 1



I 2



J 1



J 2



K1



K2

'HandZfree'™ Range'

Item	Pt. No.	RRP \$ (excl. GST)	WELS	Spout Size	Hole Size / Spacing	Description
------	---------	--------------------	------	------------	---------------------	-------------

"ELECTRONIC" TAPWARE

Basin Units	A	AUO175	\$ 372.60	5	6"	22mm	Standard Basin
	A-TV	AUO175-TV	\$ 485.00	5	6"	22mm	Stdd +Temp Valve
A-BAT	AUO175-BAT	T.B.A.		5	6"	22mm	Battery operated
Foot Control	B -1	AUO195	\$ 375.80	5	6"	22mm	Lite Duty
	B -1TV	AUO195TV	\$ 456.80	5	6"	22mm	Lite Duty- TempValve
	B-3	AUO195-HD	\$ 430.00	5	6"	22mm	Heavy Duty
	B-3TV	AUO195-HDTV	\$ 510.00	5	6"	22mm	H-Duty + Temp Valve
Wall Unit	C	AUO177	\$ 495.00		n/a		Wall -No Spout
	D	AUO178	\$ 563.00	4	6 1/2"	22mm	Wall - 6 1/2" Spout

TIME FLOW - PUSH BUTTON

PUSH BUTTON	E	GTFP3-15	\$ 165.00	5		22mm	Pillar

KNEE WAND KITS

Knee Wand	F	GKWKIT	\$ 398.84	4	6"		Knee Wand - Basic TEE Kit
	G	GKWKIT-TFTV	\$ 483.60	4	6"		

KNEE BASINS - WALL MOUNTED

KNEE BASINS	H-1	GZKOB01TV	\$ 635.00	4	6"		Time Flow / Temp. Valve /Spout & Plug
	H-2	GZKOB01	\$ 570.30	4	6"		Time Flow / Spout & Plug only -COLD only
	H-3	GZKOB02TV	\$ 610.50	4	6"		Push Flow / Temp. Valve /Spout & Plug
	H-4	GZKOB02	\$ 530.30	4	6"		Push Flow / Spout & Plug only -COLD only

STAINLESS STEEL FOOT / KNEE VALVES

FOOT Valve Short	I1	GZXSfv1S	\$ 281.22	N/A	N/A		S/S SINGLE FOOT VALVE - SHORT PEDDLE
	I2	GZXSfv2S	\$ 420.91	N/A	N/A		S/S DUAL FOOT VALVE - SHORT PEDDLE
KNEE Valve	J1	GZXSKV1	\$ 279.95	N/A	N/A		S/S SINGLE KNEE VALVE
	J2	GZXSKV2	\$ 411.55	N/A	N/A		S/S DUAL KNEE VALVE
FOOT Valve Long	K1	GZXSfv1L	\$ 299.67	N/A	N/A		S/S SINGLE FOOT VALVE - LONG PEDDLE
	K2	GZXSfv2L	\$ 476.52	N/A	N/A		S/S DUAL FOOT VALVE - LONG PEDDLE



'General Plumbing Range'

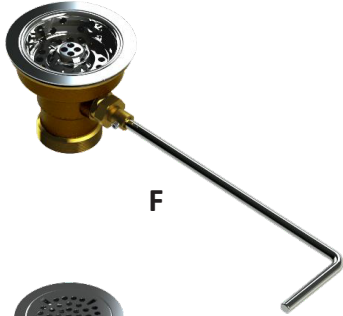
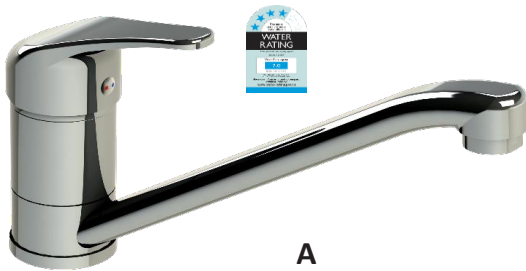

'General Plumbing Range'

Item	Pt. No.	RRP \$ (excl. GST)	WELS	Hole Size / Spacing	Description
------	---------	--------------------	------	---------------------	-------------

MIXER Faucets

Mixers	A	GMS	\$ 145.95	4	32mm	Sink Mixer - Standard
	AA	GMS-GN	\$ 156.75	4	32mm	Sink Mixer - Goose Neck
	B	GMB	\$ 145.95	4	32mm	Basin Mixer
	C	GMW	\$ 96.25	n/a		Wall Mixer

SCRAP CATCHERS™

Basket Type	D	GSC90	\$ 83.12	n/a	90mm	Scrap Catcher-Basket
	E	GSC125	\$ 124.33	n/a	125mm	Scrap Catcher-Basket
TWIST Type	F	GSC90BV	\$ 390.45	n/a	90mm	Brass Ball Valve
	G	GSC90PU	\$ 245.80	n/a	90mm	Brass Pop Up
	G1	GSC90PUPL	\$ 187.60	n/a	90mm	Plastic Pop Up
Repair Kits	H-1	GSC90/125-RRKIT	\$ 6.98	n/a		90mm Rubber Repair Kit
	H-2	GSCPU-ORR	\$ 1.50	n/a		Pop Up Rubber Ring
	I	GSC-SBK-LK	\$ 35.18	n/a		Basket Strainer-Lock-In

Wall Bib Tap

Wall	J	GEC17BC45	\$ 37.50	n/a	1/2"	Wall Bib Cock
------	---	-----------	----------	-----	------	---------------



'WASH WARE Range'



HOT WASH HOSES / Wall Hanging Bracket

For PLASTIC REEL

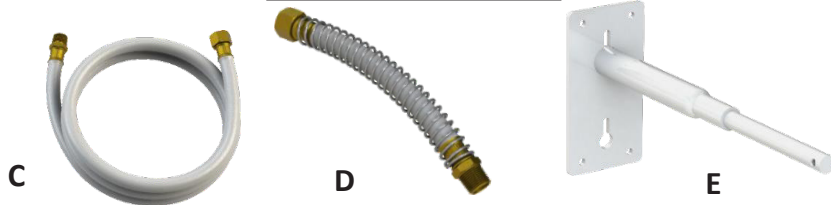

Under Counter / Wall

Reel



Wash Down Guns / Combi Guns & Brackets



COMBI GUN & Bench Pull Out Gun KITS



'WASH WARE Range'

Item	Pt. No.	RRP \$ (excl. GST)	WELS	Inlet / Outlet	Dimensions	Description
------	---------	--------------------	------	----------------	------------	-------------

HOT WASH HOSE REELS

Hot Wash Reel & Gun	Item	Pt. No.	RRP \$ (excl. GST)	WELS	Inlet / Outlet	Dimensions	Description
	A1	GTHR1215RED	\$ 552.00	n/a	3/4" / 1/2"	15mt	Hot Wash Hose Reel
	A2	GTHR1215REDSG	\$ 788.10	n/a	3/4" / n.a.	15mt	Hot Wash Hose Reel & Wash Down Gun
	B1	GTHRSS1215	\$ 1,761.00	n/a	3/4" / 1/2"	15mt S/S	Hot Wash Hose Reel
	B2	GTHRSS1215SG	\$ 2,094.00	n/a	3/4" / n.a.	15mt S/S	Hot Wash Hose Reel & Wash Down Gun
	N	GTHR2984	\$ 2,039.84	n/a	1/2" / n.a.	3.6mt	Hose. 60c Max. Temp. 200 psi Max.

HOT WASH HOSES & Accessories

Hoses & Parts	Item	Pt. No.	RRP \$ (excl. GST)	WELS	Inlet / Outlet	Dimensions	Description
	C1	GTHWH02MF	\$ 71.25	n/a	1/2" M&F	2 mt	Hot Wash Hose - MxF
	C2	GTHWH05MF	\$ 119.30	n/a	1/2" M&F	5 mt	Hot Wash Hose - MxF
	C3	GTHWH10MF	\$ 188.10	n/a	1/2" M&F	10 mt	Hot Wash Hose - MxF
	C4	GTHWH15MF	\$ 256.91	n/a	1/2" M&F	15 mt	Hot Wash Hose - MxF
	C5	GTHWH20MF	\$ 296.10	n/a	1/2" M&F	20 mt	Hot Wash Hose - MxF
	C6	GTHWH25MF	\$ 358.65	n/a	1/2" M&F	25 mt	Hot Wash Hose - MxF
	D	GTHWHSGEXT	\$ 50.25	n/a	1/2" M&F	250mm	Spring Guard Extension
E	GTHRWBKT-MT	\$ 127.50	n/a	n/a		Metal Wall Bracket for Plastic Reel	

WASH DOWN GUNS

Combi & Wash Down Guns	Item	Pt. No.	RRP \$ (excl. GST)	WELS	Inlet / Outlet	DESCRIPTION
	F	GUNNA-BLU	\$ 234.00	n/a	1/2"	Wash Down Gun - 1/2" Female Swivel
	G	GUNNA-WH	\$ 234.00	n/a	1/2"	Wash Down Gun - 1/2" Female Swivel
	H1	GCOMBIG12WB	\$ 120.00	n/a	1/2"	Combi Gun & Bracket
	H2	GCOMBIG12	\$ 105.00	n/a	1/2"	Combi Gun ONLY
	H3	GCOMBIGWB	\$ 45.00	n/a		Combi Gun BRACKET ONLY
	I1	GPISTOLGUNWB	\$ 233.15	n/a	1/2"	Pistol Vari Spray Gun & Bracket
	I2	GPISTOLGUN	\$ 189.75	n/a	1/2"	Pistol Vari Spray Gun ONLY

Watermarked Wash KITS

WASH KITS	Item	Pt. No.	RRP \$ (excl. GST)	WELS	Inlet / Outlet	DESCRIPTION
	J1	GCOMBIKIT-WMK	\$ 291.09	n/a	1/2 x 3/4	WMK -Combi Kit-2mt Hose, Dual Check Valve
	J2	GCOMBIKIT	\$ 188.84	n/a	1/2"	Combi Kit - 2mt Hose & Gun only
	K1	GPISTOLKIT-WMK	\$ 293.98	n/a	1/2 x 3/4	WMK - Pistol Kit - 2.0 mt & Dual CV
	L1	GPISTOLBPO-15	\$ 308.38	n/a	1/2"	Pull Thru Kit 1.5 mt Hose
	L2	GPISTOLBPO-20	\$ 335.00	n/a	1/2"	Pull Thru Kit 2 mt Hose
	M	GPANROOMKIT	\$ 409.53	n/a	1/2"	Pan Room Kit- 2mt Hose & Dual CV

'ACCESSORIES & SPARE PARTS Range'

Universal Hoses / Fisher Hoses / RinseMaid Hoses

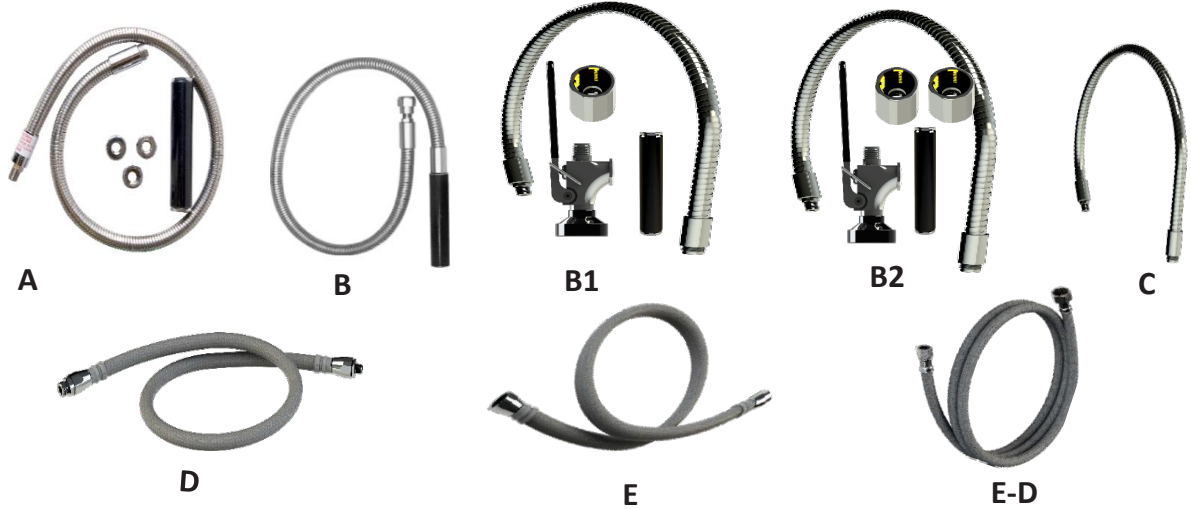

Universal Gun / Fisher Guns/ Special Purpose Guns

Gun Parts / TAP Repair KITS



GUN & TAP Repair KITS

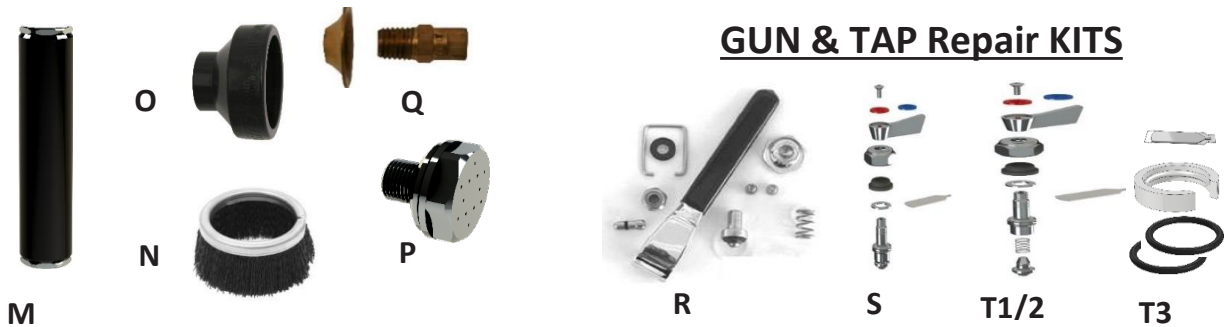

Mounting Kits / Inlet Hoses / Spring Guard



'ACCESSORIES & SPARE PARTS Range'

Item	Pt. No.	RRP \$ (excl. GST)	WELS	Size / Dimension	Description
------	---------	--------------------	------	------------------	-------------

Fisher PRE RINSE HOSES -Armourflex Covering

Fisher Pre Rinse Hoses	A1	GF2918A	\$ 245.15	Adaptor 1	915mm (36")	Universal PR Hose -Stdd Unit
	A2	GF2918A-C	\$ 245.15		660mm (26")	Universal PR Hose - Café
	A3	GF2918A-60	\$ 345.15		1525mm (60")	Universal PR Hose - Long
	B	GF2918	\$ 183.74	For adaptor See M1/2/3 on page 32/33	915mm (36")	Replacement 4 T&S-Encore Hose
	B1	GF2918-2949-1	\$ 373.55		Hose + Gun + Handle + Adaptor 2	
	B2	GF2918-2949-2	\$ 393.55	Hose + Gun + Handle + Adaptors 1 & 2		
	C1	GF2914	\$ 166.32		915mm (36")	Fisher Hose only 1/4m x3/4 m
	C2	GF2914-C	\$ 166.32		660mm (26")	Fisher Hose only 1/4m x3/4 m
	C3	GF2914-15	\$ 150.98		380mm (15")	Fisher Hose only 1/4m x3/4 m
	C4	GF2914-60	\$ 219.06		1525mm (60")	Fisher Hose only 1/4m x3/4 m
	C5	GF2914-96	\$ 225.63		2440mm (96")	Fisher Hose only 1/4m x3/4 m

RinseMaid PRE RINSE HOSES - Plastic Covering

SWIVEL FEMALE ENDS

Rinse Maid PR Hoses	D1	GRM4236	\$ 132.00		915mm (36")	RM Hose 1/4"BSP m x 3/4m UNC
	D2	GRM4226	\$ 105.00		660mm (26")	RM Hose 1/4"BSP m x 3/4m UNC
	D3	GRM4336	\$ 105.00		915mm (36")	RM Hose 1/2 bsp F x 1/2 bsp F
	D4	GRM4326	\$ 96.00		660mm (26")	RM Hose 1/2 bsp F x 1/2 bsp F
	E1	GRM4136	\$ 132.00		915mm (36")	RM Hose 7/8unf FI x 7/8 FI
	E2	GRM4147	\$ 168.00		1200mm (47")	RM Hose 7/8unf FI x 7/8 FI

HOSE REPLACEMENT for SINGLE LEVER MIXER DOMESTIC PRE RINSE - 10mm S/S Braid Hose-PVC Coated

Hose Replacement	E-D 1	GPRD600	\$ 57.00		600mm	Anti Kink 10mm S/S Braided Hose PVC COATED w/- 3/8 female x 1/2 female
	E-D 2	GPRD750	\$ 60.00		750mm	
	E-D 3	GRPD860	\$ 63.00		800mm	
	E-D 4	GRPD915	\$ 67.00		915mm (36")	

Spray Guns / Glass / Pot Fillers

DESCRIPTION

Fisher Spray / Glass / Pot Filling Guns	F	GF2949-2913A	\$ 266.84	6	Universal Pre Rinse Gun suit most brands	
	F1	GF2949HDL	\$ 240.50		Fisher Spray Valve & Handle only (for Fisher Hose only)	
	G1	G2949-B	\$ 199.81		Fisher Spray Valve - Jet Spray (Stdd)	
	G2	G2949-SS	\$ 268.59		Fisher Spray Valve - All S/S -Jet Spray	
	H	G50TV-S	\$ 208.13		Fisher Spray Valve - Shower Head	
	I	G50GF	\$ 204.53		Fisher Glass / Jug Valve - Aerator Head	
	J	G50PF	\$ 337.50		Fisher Pot Fill Valve - Hook Aerator Head	
	K	G50JT5208	\$ 136.32		Fisher Handle & Jet Tip	
	L	G50SH5209	\$ 194.32		Fisher Handle & Shower Head	

Spray Guns Spare Parts & Repair Kit

Fisher Spray Guns	M1	G5208	\$ 73.32		Fisher Handle suit spray valve
	M2	G5208SS	\$ 87.50		Fisher Handle suit spray valve- All S/S
	N	G50BR	\$ 30.00		Fisher Spray Valve BRUSH
	O1	G50BM-BK	\$ 36.00		Fisher Spray Valve Bumper - BLUE
	O2	G50BM-BLU	\$ 36.00		Fisher Spray Valve Bumper - BLACK
	P	G50SH	\$ 75.00		Fisher Shower Head Tip Only
	Q	G50ST	\$ 27.00		Fisher Jet Spray & Washer Tip Only
	R	G50KIT	\$ 158.25		Fisher Repair Kit for spray valve

Faucet Spare Parts & Repair Kit

Fisher & Stain-less Tap Parts & Kits	S	G25RK-SS	\$ 88.94		Fisher Pot Filler Repair Kit
	T1	GS03RKC-SS	\$ 88.94		Fisher / Stainless Faucet Repair Kit - COLD
	T2	GS03RKH-SS	\$ 88.94		Fisher / Stainless Faucet Repair Kit - HOT
	T3	G-SPKIT	\$ 12.50		Fisher / Stainless / RM / EC / Q Spout Repair Kit
	U1	G03MK	\$ 46.00		Fisher / Stainless Faucet Mounting Kit
	U2	G03MKEC	\$ 46.00		Mounting Kit suit RM / EC / Q Faucet
	V1	G03IH	\$ 66.00		Inlet Hoses Fisher / Stainless Faucet (pr)
	V2	G03IHEC	\$ 66.00		Inlet Hoses RM / EC / Q Faucet (pr)
	W1	G8101	\$ 55.00		Spring Guard - Stdd "J"
	W2	G8101Q	\$ 65.00		Spring Guard - Supa Strong "J?"
W3	G8101C	\$ 55.00		Spring Guard - Cafe "J"	

'ACCESSORIES & SPARE PARTS Range'

Pot Fillers / Risers / Wall Brackets



A1-4

B1-6

C1-5

D

E

F

G

Hook & Spring Retainer / Quick Release / Handle / Line Retractor

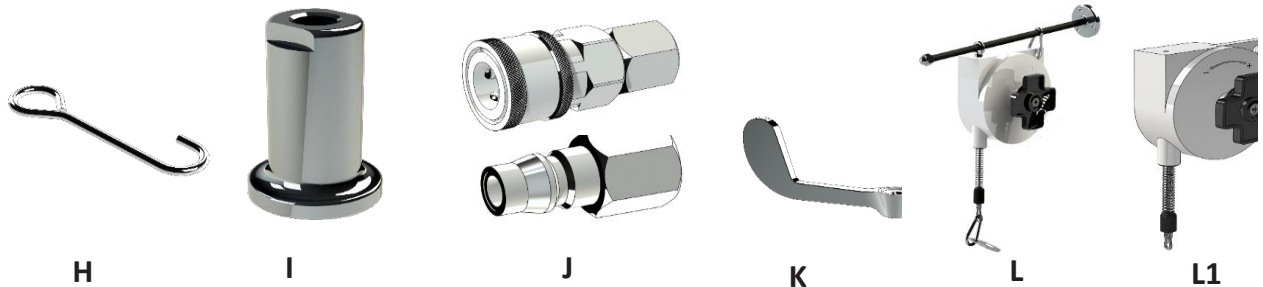

H

I

J

K

L

L1

Sockets / Adaptors / Bush / Nipples

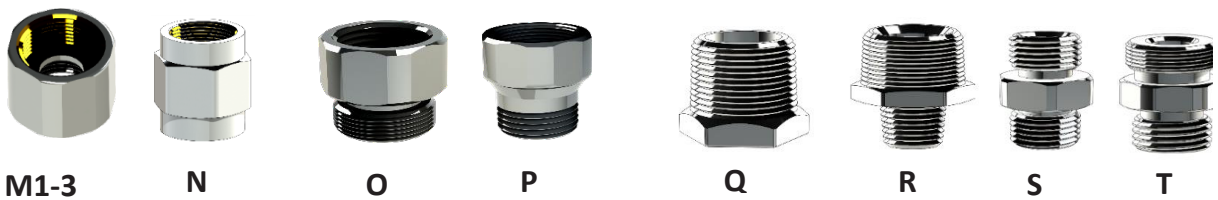

M1-3

N

O

P

Q

R

S

T

Hanging Wall Brackets

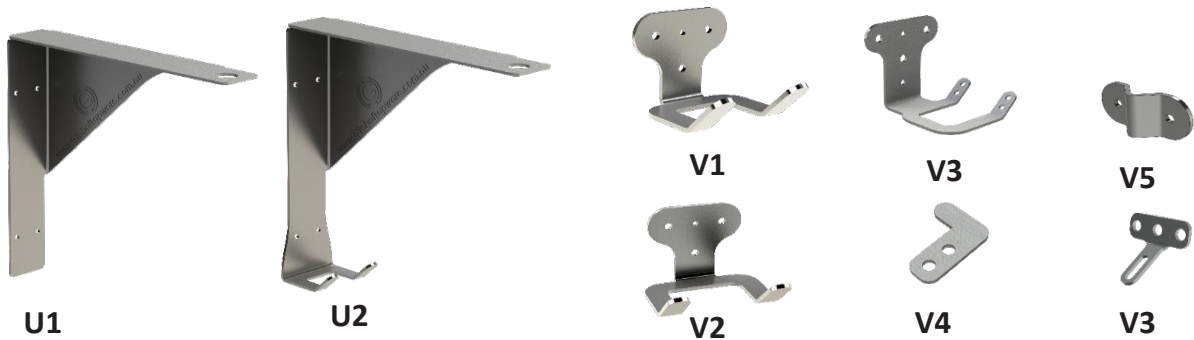

U1

U2

V1

V3

V5

V2

V4

V3

'ACCESSORIES & SPARE PARTS Range'

Item	Pt. No.	RRP \$ (excl. GST)	WELS	Spout Lgth	Description
------	---------	--------------------	------	------------	-------------

Fisher / Stainless / RinseMaid - Pot Fillers

Pot Fillers - Chrome & S/S	A1	G-506	\$ 273.81	3	6"	Add-On Pot Filler - Chrome
	A2	G-508	\$ 273.81	3	8"	Add-On Pot Filler - Chrome
	A3	G-510	\$ 273.81	3	10"	Add-On Pot Filler - Chrome
	A4	G-512	\$ 273.81	3	12"	Add-On Pot Filler - Chrome
	AA1	G-506SS	\$ 478.93	3	6"	Add-On Pot Filler - STAINLESS STEEL
	AA2	G-508SS	\$ 478.93	3	8"	Add-On Pot Filler - STAINLESS STEEL
	AA3	G-510SS	\$ 478.93	3	10"	Add-On Pot Filler - STAINLESS STEEL
	AA4	G-512SS	\$ 478.93	3	12"	Add-On Pot Filler - STAINLESS STEEL
	AA5	G-514SS	\$ 478.93	3	14"	Add-On Pot Filler - STAINLESS STEEL

Fisher / RinseMaid - Risers

					length	
Risers - Stainless Steel	B1	GF8001	\$ 40.00		1 1/2"	Fisher Riser - Stainless Steel
	B2	GF8002	\$ 41.00		2 1/2"	Fisher Riser - Stainless Steel
	B3	GF8004.5	\$ 42.00		4 1/2 - 5"	Fisher Riser - Stainless Steel
	B4	GF8010	\$ 46.00		10 1/2"	Fisher Riser - Stainless Steel
	B5	GF8016	\$ 49.00		16"	Fisher Riser - Stainless Steel
	B6	GF8021	\$ 60.00		21"	Fisher Riser - Stainless Steel
Risers - Chrome	C1	GRM8002	\$ 43.00		2 1/2"	RinseMaid Riser - Chrome
	C2	GRM8004	\$ 44.00		4 1/2"	RinseMaid Riser - Chrome
	C3	GRM8010	\$ 49.00		10 1/2"	RinseMaid Riser - Chrome
	C4	GRM8016	\$ 52.00		16"	RinseMaid Riser - Chrome
	C5	GRM8021	\$ 63.00		21"	RinseMaid Riser - Chrome

Fisher / RinseMaid - Wall Brackets - Hooks - Spring Retainer

Spout Ext. Risers - Wall Bracket - Hook - Spring	D	MTO	Cost on Application			Spout Extensions - Female Swivel x Flat Seat
	E	MTO	Cost on Application			Spout Extensions - Female Swivel x Male Swivel
	F	GF8310	\$ 72.50	220mm		Fisher Wall Bracket - S/S
	G	GRM8310	\$ 66.00	220mm		RinseMaid Wall Bracket - S/S
	H	G8206SS	\$ 12.90	150mm		PR Hose Hook - S/S
	I	GS533814HEX	\$ 52.50			Spring Retainer & Hose to Riser Connector
	J1	GQR14FCOUPSS	\$ 132.78			Quick Release Female Coupling - 1/4" fi - S/S
	J2	GQR14FPLUGSS	\$ 31.59			Quick Release Male Plug - 1/4" fi - S/S

Special Product - Lever Handles - Line Retractors

Special Product	K1	GFS-PL-1	\$ 63.39		Fisher / Stainless Tap Handle - Paddle Lever x 1
	K2	GFS-PL-2	\$ 126.79		Fisher / Stainless Tap Handle - Paddle Lever x 2
	L	GLRWBKT	\$ 144.00		Line Retractor & Wall Bracket
	L1	GLRW	\$ 83.50		Line Retractor only

Adaptors & Fittings

Sockets - Bush - Nipples	M1	G531434CP	\$ 27.72		Socket 1/4" NPT x 3/4" UNC - TYPE 1 - CP
	M2	G531412CP	\$ 27.72		Socket 1/4" NPT x 1/2" BSP - TYPE 2 - CP
	M3	G531234CP	\$ 27.72		Socket 1/2" BSP x 3/4" UNC - TYPE 3 - CP
	N	G5338CP	\$ 3.51		Socket 3/8" BSP - CP
	O	G553412	\$ 26.40		Adaptor 3/4" UNC FI x 1/2" BSP MI - CP
	P	G5512F78M	\$ 27.40		Adaptor 1/2" BSP FI x 7/8 UNF MI - CP
	Q	G541438SS	\$ 8.40		Bush 3/8" BSP MI x 1/4" BSP FI - S/S
	R	G561412CP	\$ 7.04		Nipple - Reducing 1/4" BSP x 1/2" BSP - CP
	S	G561234SS	\$ 26.40		Nipple - Reducing 3/4" UNC x 1/2" BSP - S/S
	T	G563478SS	\$ 26.40		Nipple - Reducing 3/4" UNC x 7/8" UNF - S/S

Wall Brackets

Hose Hanging	U1	GHWBK-MK3	\$ 89.73		S/S PR Hose Hanging Wall Bracket only
	U2	GHWBKHK-MK1	\$ 95.00		S/S PR Hose Hanging Wall Bracket c/w Gun Hook
Wall Brackets	V1	GBKT-N -Mk2	\$ 45.64		S/S Wall / Pipe Gun Bracket - Narrow
	V2	GBKT-L-Mk2	\$ 45.64		S/S Wall / Pipe Gun Bracket - Wide
	V3	GBKTSIDESS	\$ 45.64		S/S Wall / Pipe Gun Bracket - Side
	V4	GBKT-HOOKSS	\$ 5.40		S/S Bracket Hook
	V5	GBKTCLAMPSS	\$ 37.42		S/S Pipe Clamp for Wall brackets
	V6	M-BL-CSWBKT	\$ 8.50		S/S Wall Bracket for Cleaners Sink

'ACCESSORIES & SPARE PARTS Range'

SPOUTS - Standard & Goose Neck



3/4" Fisher Range only'



'Other Brand PR Parts ' - Service Line only'



'ACCESSORIES & SPARE PARTS Range'

Item	Pt. No.	RRP \$ (excl. GST)	WELS	Size	Description
------	---------	--------------------	------	------	-------------

Fisher / Stainless / RinseMaid - STANDARD SPOUTS

Standard Spouts - C.P.	A1	G3006	\$ 75.96	3	6"	Standard Swivel Spout - Chrome
	A2	G3008	\$ 82.26	3	8"	Standard Swivel Spout - Chrome
	A3	G3010	\$ 82.26	3	10"	Standard Swivel Spout - Chrome
	A4	G3012	\$ 88.61	3	12"	Standard Swivel Spout - Chrome
	A5	G3014	\$ 88.61	3	14"	Standard Swivel Spout - Chrome
	A6	G3016	\$ 94.91	3	16"	Standard Swivel Spout - Chrome
Standard Spouts - S/S	AA1	GS3006	\$ 112.01	3	6"	Standard Swivel Spout - Stainless Steel
	AA2	GS3008	\$ 114.44	3	8"	Standard Swivel Spout - Stainless Steel
	AA3	GS3010	\$ 116.34	3	10"	Standard Swivel Spout - Stainless Steel
	AA4	GS3012	\$ 119.34	3	12"	Standard Swivel Spout - Stainless Steel
	AA5	GS3014	\$ 121.77	3	14"	Standard Swivel Spout - Stainless Steel
	AA6	GS3016	\$ 126.63	3	16"	Standard Swivel Spout - Stainless Steel

Fisher / Stainless / RinseMaid -GOOSENECK SPOUTS

Gooseneck Spouts	B1	G3106	\$ 102.29	3	6"	Gooseneck Swivel Spout - Chrome
	B2	G3112	\$ 114.44	3	12"	Gooseneck Swivel Spout - Chrome
	BB1	GS3106	\$ 126.63	3	6"	Gooseneck Swivel / Fix Spout - Stainless
	BB2	GS3112	\$ 141.26	3	12"	Gooseneck Swivel / Fix Spout - Stainless
	C1	G3206	\$ 112.01	3	6"	Gooseneck Fixed Spout - Chrome
	C2	G3212	\$ 118.76	3	12"	Gooseneck Fixed Spout - Chrome

Fisher / Stainless / RinseMaid -DOUBLE SWIVEL SPOUTS w/- END TAP

Double Swivel Spout w/- end	D	G3407	\$ 153.00	CP	7"	Double Swivel Spout Attachment- Chrome
	DS	GS3407	\$ 153.41	Stainless	7"	Double Swivel Spout Attachment - S/S
	E	G3311	\$ 355.50	CP	11"	Swivel Spout w/- End Tap - Chrome
	ES	GS3311	\$ 431.01	Stainless	11"	Swivel Spout w/- End Tap - S/S
	F	G3218	\$ 508.50	CP	18"	Double Swivel Spout w/- End Tap -CP
	FS	GS3218	\$ 584.42	Stainless	18"	Double Swivel Spout w/- End Tap - S/S
	EF	GFZSPOUTHDL	\$ 110.35			Replacement Handle for End Tap

Fisher 3/4" SERVICE KITS

3/4" Service Kits & Parts	G	GFZ5000-0002	\$ 198.00	n/a	14"	Standard Spout 3/4" - no Aerator- CP
	H1	GFZ5000-0012	\$ 196.94			Tap Repair Kit - Hot - Check Type
	H2	GFZ5000-0013	\$ 196.94			Tap Repair Kit - Cold - Check Type
	I1	GFZX5000-3305	\$ 248.33			Stem Adaptor - Cold Side
	I2	GFZX5000-3308	\$ 248.33			Stem Adaptor - Hot Side
	J	GFZ5000-0004	\$ 66.50			3/4 Jumper Retainer Assembly
	K	GFZ5000-5002	\$ 9.00			3/4 Fibre Washer

ENCORE - Service Kts & Parts

ENCORE Service Parts	L	GZ-ENC-50SV	\$ 195.36			Encore Spray Valve - Shower Head
	M	GZ-ENC-SGG RIP	\$ 69.04			Encore Handle Grip for Spray Valve
	N	GZ-ENC-50RK	\$ 75.15			Encore Valve Push Button Repair Kit
	O	GZ-ENC-PFRK	\$ 88.80			Encore - Pot Filler Repair Kit
	P1	GZ-ENC-TRKC	\$ 88.80			Encore - Tap Repair Kit - COLD
	P2	GZ-ENC-TRKH	\$ 88.80			Encore - Tap Repair Kit - HOT

OTHER BRANDS - Service Kts & Parts

UNIVERSAL HOSE REPLACEMENT for SINGLE LEVER MIXER DOMESTIC PRE RINSE - 10mm S/S Braid Hose-PVC Coated

Hose Replacement	Q	GZ-8101SG	\$ 97.00			Spring Guard for Domestic Pre Rinse
	R1	GPRD600UK	\$ 79.00		600mm	Anti Kink 10mm S/S Braided Hose, PVC Coated
	R2	GPRD750UK	\$ 81.00		750mm	w/- 3/8 female x 1/2 female + 3/8 x M15 Nipple
	R3	GRPD860UK	\$ 84.00		800mm	(Designed to suit Gentech, Wolfen, Aquline, Others)
	R4	GRPD915UK	\$ 88.00		915mm (36")	

TAP BODIES only - Swivel & Fixed outlets

COMMON TYPES

STAINLESS STEEL - Deck / Hob

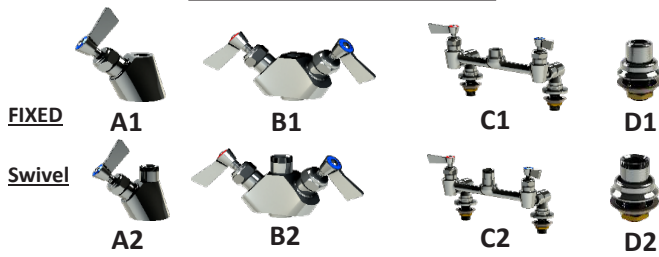

HOB	Item No.	Part Number	RRP \$ (excl GST)
Stainless Steel Taps	A1	GS02	\$ 295.00
	A2	GS02S	\$ 320.15
	B1	GS03	\$ 495.00
	B2	GS03S	\$ 477.62
	C1	GS04	\$ 467.26
	C2	GS04S	\$ 492.26
	D1	GS06	\$ 121.50
	D2	GS06S	\$ 121.50

STAINLESS STEEL - Wall

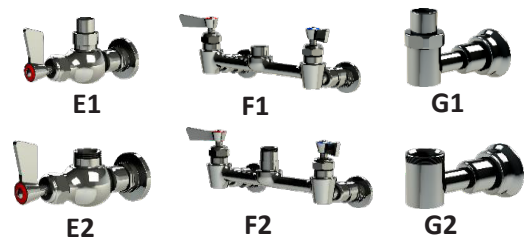

WALL	Item No.	Part Number	RRP \$ excl GST
Stainless Steel Taps	E1	GS11	\$ 406.67
	E2	GS11S	\$ 457.79
	F1	GS15	\$ 547.88
	F2	GS15S	\$ 572.88
	G1	GS16	\$ 196.88
	G2	GS16S	\$ 160.88

Chrome - Deck / Hob



HOB	Item No.	Part Number	RRP \$ (excl GST)
Chrome BrassTaps	H1	GEC0	\$ 326.28
	H2	GEC01S	\$ 300.28
	I1	GEC03	\$ 279.97
	I2	GEC03S	\$ 321.58
	J1	GEC05	\$ 560.12
	J2	GEC05S	\$ 534.12
	K1	GEC06	\$ 120.00
	K2	GEC06S	\$ 120.00

Chrome - Wall

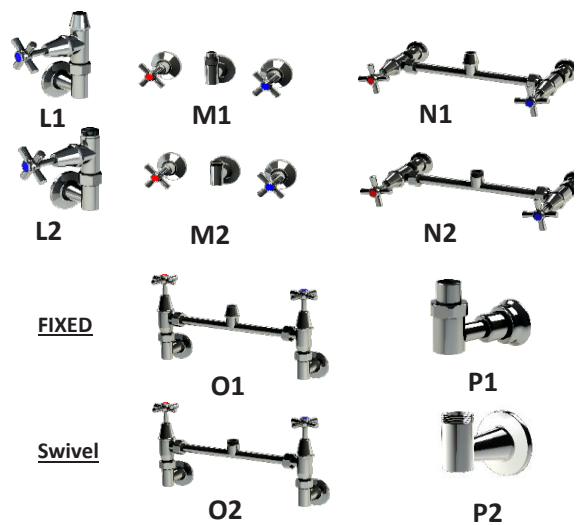

WALL	Item No.	Part Number	RRP \$ excl GST
Chrome BrassTaps	L1	GEC11	\$ 397.40
	L2	GEC11S	\$ 349.11
	M1	GEC13	\$ 200.00
	M2	GEC13S	\$ 165.00
	N1	GEC14	\$ 588.00
	N2	GEC14S	\$ 553.00
	O1	GEC15	\$ 700.00
	O2	GEC15S	\$ 673.00
	P1	GEC16	\$ 120.00
	P2	GEC16S	\$ 120.00

'PRODUCT DRAWINGS'

GLOBAL FISHER Café Models

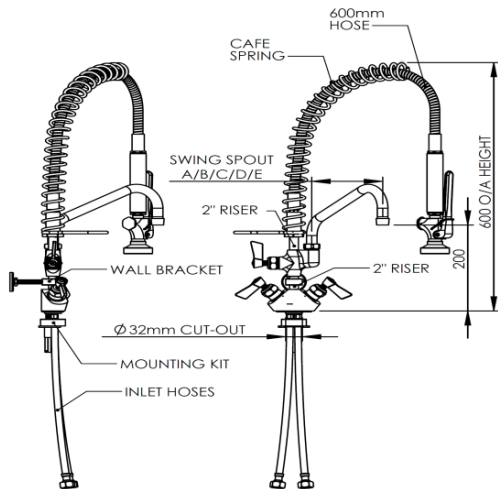

GLOBAL FISHER GLOBAL RinseMaid Standard Models

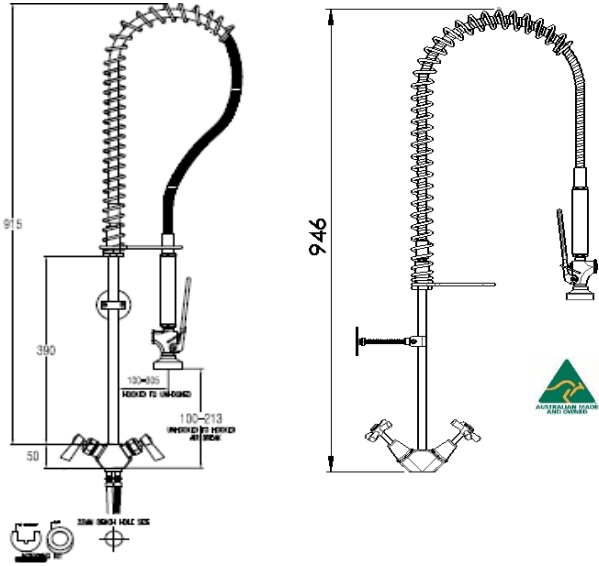

GLOBAL FISHER Wall Mount c/w Pot Filler

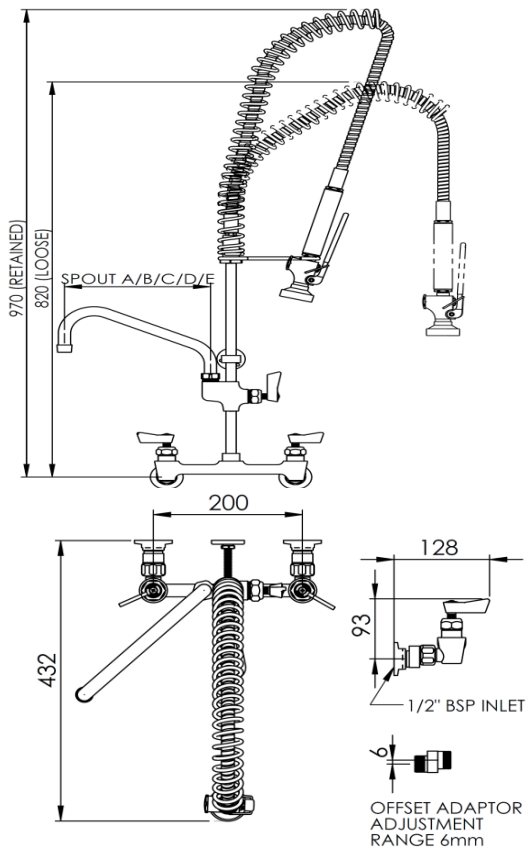

GLOBAL FISHER GLOBAL RinseMaid with ADD-ON POT FILLER

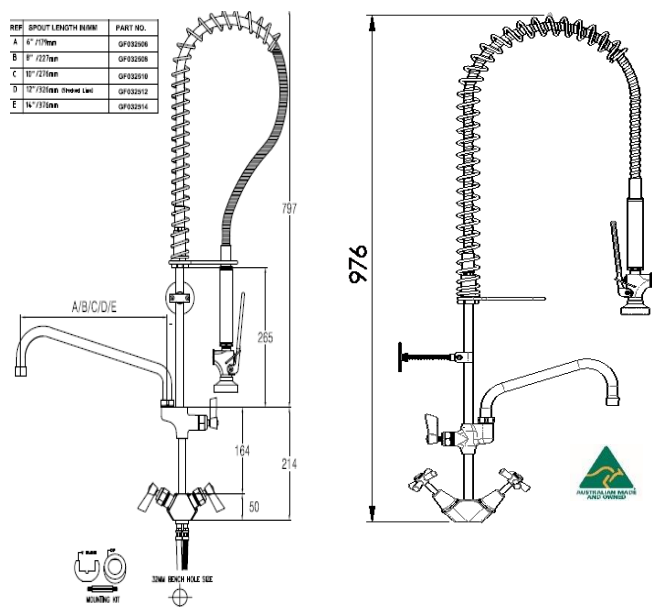

'PRODUCT DRAWINGS'

HOT WASH HOSE REEL

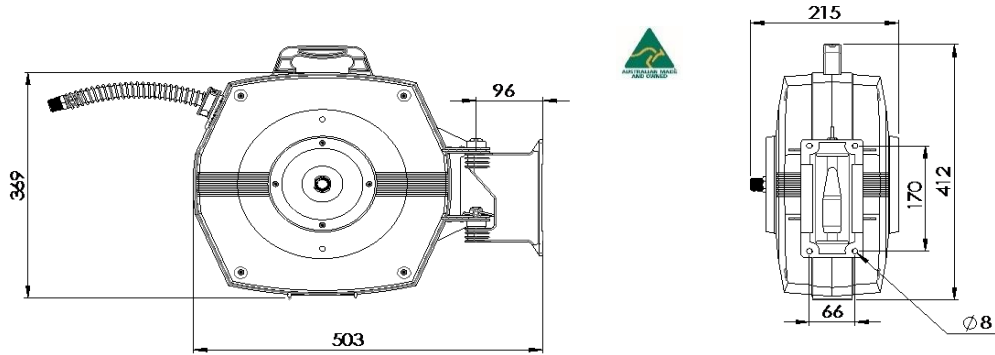

KETTLE / WOK Filling Taps

Easy Clean Wall Stops & Outlet

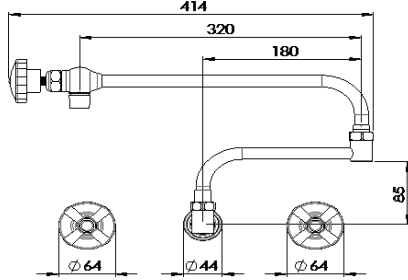

Stainless Single Deck Tap Outlet only

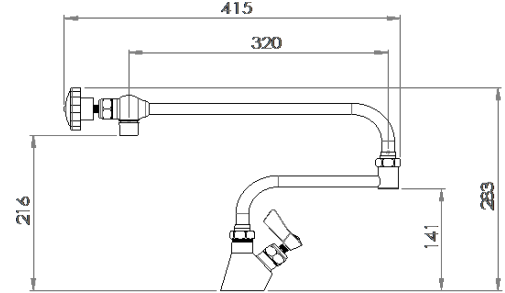

HandZfree Taps

Push Button - Timeflow

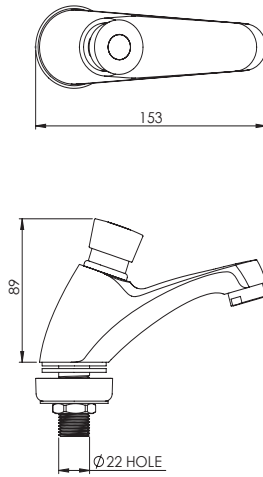

Auto Electronic -Time Flow

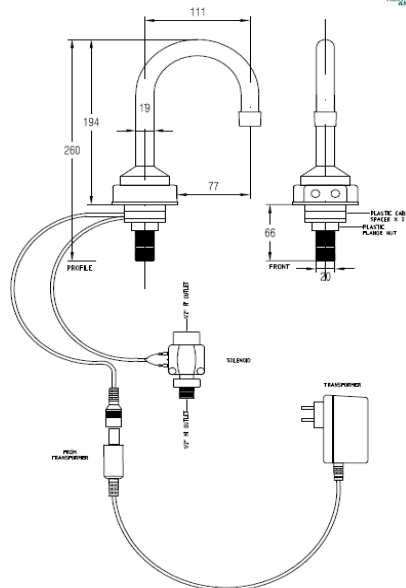

MIXERS

Sink & Basin Mixers

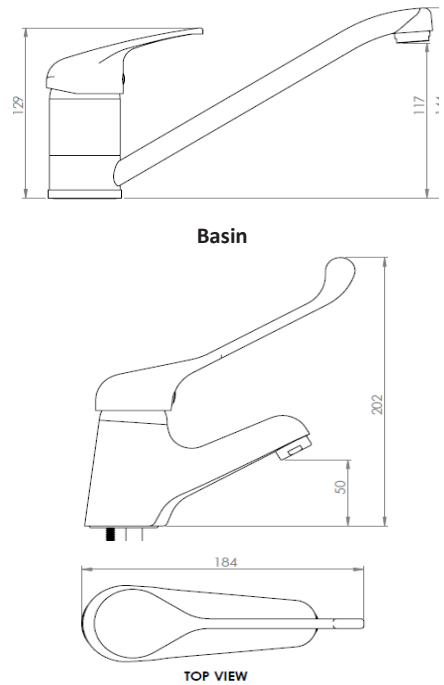

Technical Information - 2017

TAPWARE

Temperature:	Min 4° C - 65° C max (Constant - Occasional Peaks up to 85° C)
Pressure:	200 psi max Static, (1379 kpa max. Static)
Inlet Hoses Temp.:	Working 65° C, with peaks to 85° C
Inlet Hoses Pressure:	Working 65 psi, with peaks to 200 + psi

Fisher

Tap Body Material:	Stainless Steel - 304
Pot Filler & Spout Material:	Brass w/- Chrome Plating
WELS Star Rating:	3 Star / 9 lpm on all spouts
Gun Body & Handle Material:	Brass w/- Chrome Plating
WELS Star Rating:	6 Star / 3.5 lpm Gun only

Fisher Pre Rinse HOSE

Temperature:	Min 4° C - 60° C max
Pressure:	200 psi max Static, (1379 kpa max. Static)
Outer Sheathing Material:	Stainless Steel (304) Spiral Armourflex
Inner Tube:	3 Ply Rubber
End fittings:	Stainless Steel (303)

Stainless Steel

Tap Body Material:	Stainless Steel - 304 on all 'Global Fisher & Stainless' ranges
Pot Filler & Spout Material:	Stainless Steel - 304 on all 'Global Stainless' ranges
WELS Star Rating:	3 Star / 9 lpm on all spouts
Gun Body & Handle Material:	Stainless Steel - 304 on all 'Global Stainless' ranges
WELS Star Rating:	6 Star / 3.5 lpm Gun only

RinseMaid / EC / Q / Mixers / Autoflo / Time Flo

Tap Body Material:	Brass w/- Chrome Plating
Spout Material:	Brass w/- Chrome Plating
WELS Star Rating:	3 Star / 9 lpm on all RM / EC / Q spouts
WELS Star Rating:	4 Star / 7.5 lpm on all Mixers / TimeFlo
WELS Star Rating:	5 Star / 6.5 lpm on all Autoflo
Fisher Gun Body Material:	Brass w/- Chrome Plating.
WELS Star Rating:	6 Star / 3.5 lpm Gun only

Rinse Maid™ Pre Rinse HOSE

Temperature:	Min 4° C - 60° C max
Pressure:	200 psi max Static, (1379 kpa max. Static)
Outer Sheathing Material:	Stainless Steel Braid w/- Plastic Coating
Inner Tube:	Anti-Kink Hose - 12mm i.d.
End fittings:	Brass & Chrome Plated Brass Nut

Hot Wash Hose Reel & Wash-Down Gun

Reel & Gun Body Material:	Reel = Plastic	Gun = S/S c/w Rubber Cover
Pressures & temperature:	Reel = Max. 203 psi / 80c	Gun = Max. 90 psi / 80c
Inlet & Outlets:	Reel = ½" Male outlet	Gun = ½" Female inlet



High Quality Commercial Tapware & Products

3+ Ranges certified
Australian Made

Your Pre Rinse Specialists



Phone: 1300 852 515 or 07 3855 2350

Fax: 07 3112 1916

Email: sales.info@globaltapware.com

www.globaltapware.com.au